



RANGER



MODELS, PARTS,
GARMENTS & ACCESSORIES

2024

HARDEST WORKING.
**SMOOTHEST
RIDING.**



#1 UTILITY SIDE-BY-SIDE

For the past two decades, RANGER has set the standard through unrivaled strength, unmatched capability and next-level comfort, making it the number one utility side-by-side for over 10-years running.

POLARIS **RANGER**

- 5 CHOOSE YOUR RANGER
- 6 FEATURES
- 10 VEHICLE SPECIFICATIONS

14 RANGER XD 1500 ACCESSORIES

- 15 WINDSHIELDS & REAR PANELS
- 16 DOORS
- 17 CAB COMFORT & CONVENIENCE
- 18 WINCHES
- 19 PROTECTION
- 20 AUDIO
- 21 STORAGE

27 1000 / XP 1000 / XP KINETIC ACCESSORIES

- 30 ROOFS
- 32 WINDSHIELDS & REAR PANELS
- 34 DOORS
- 38 CAB COMFORT & CONVENIENCE
- 39 WINCHES
- 40 PROTECTION
- 42 AUDIO
- 46 STORAGE

52 SP 570 ACCESSORIES

- 52 ROOFS & DOORS
- 54 WINDSHIELDS & REAR PANELS
- 56 AUDIO, CAB COMFORT & CONVENIENCE
- 57 PROTECTION & WINCHES
- 58 STORAGE

60 YOUTH ACCESSORIES

62 COMMON ACCESSORIES

- 62 ELECTRICAL ACCESSORIES
- 65 TRACKS
- 66 HUNT
- 68 WINCHES
- 70 LIGHTING
- 72 WHEELS & TYRES



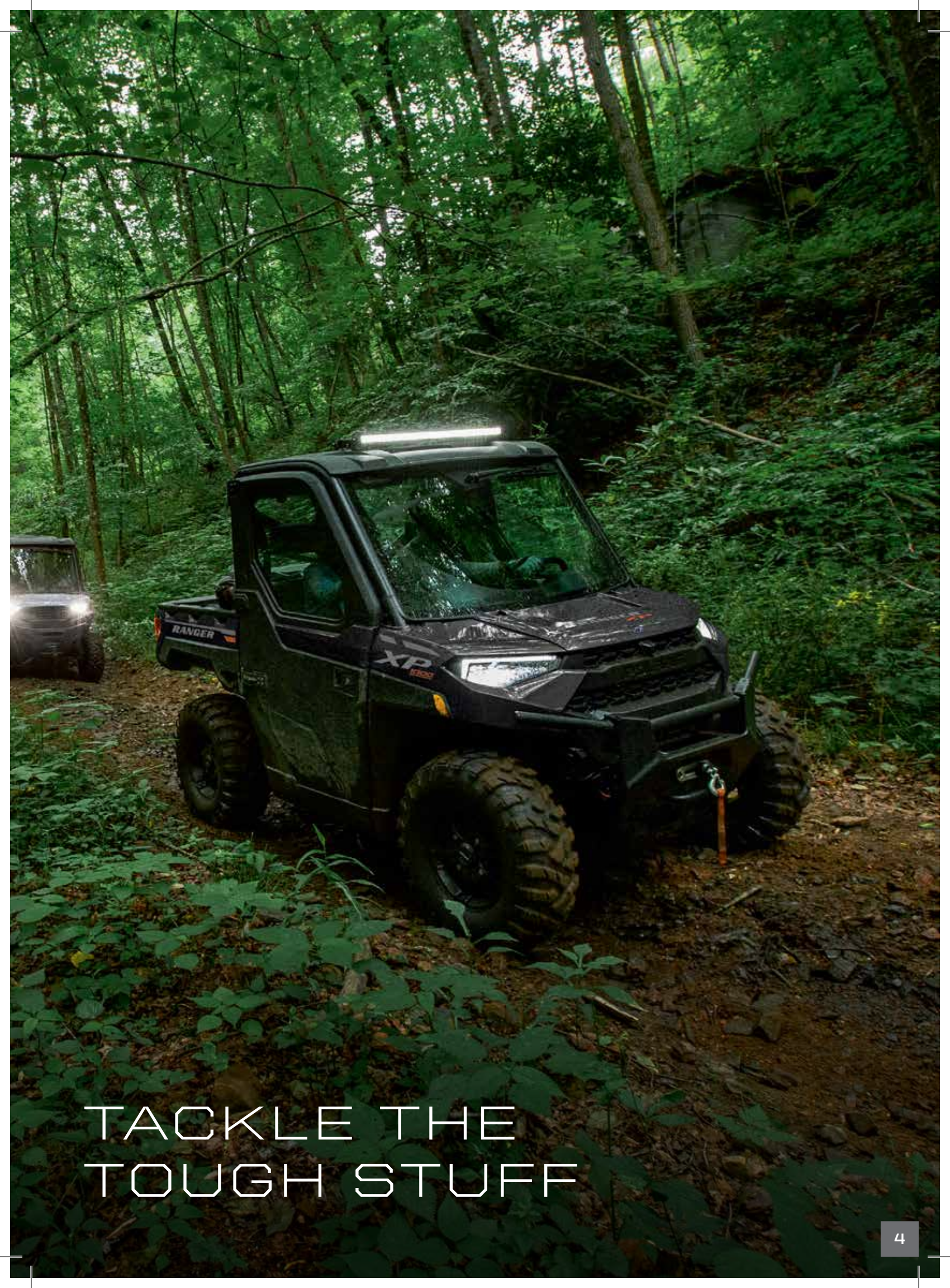

TACKLE THE
TOUGH STUFF

CHOOSE YOUR RANGER
MID - SIZE



RANGER SP 530



RANGER 570 HD ADC



RANGER SP 570 PREMIUM



RANGER SP 570 NORTHSTAR

FULL - SIZE



RANGER 1000 EPS



RANGER 1000 PREMIUM



RANGER XP 1000 HD ADC



RANGER DIESEL HD ADC



RANGER XP 1000
 NORTHSTAR PREMIUM



RANGER XD 1500 PREMIUM



RANGER XD 1500
 NORTHSTAR PREMIUM



RANGER XD 1500
 NORTHSTAR ULTIMATE

● AVAILABLE IN CAMO



RANGER XP KINETIC PREMIUM **EV**



RANGER XP KINETIC ULTIMATE **EV**

CREW



RANGER CREW SP 570 PREMIUM



RANGER CREW 1000 PREMIUM



RANGER CREW XP 1000 PREMIUM



RANGER CREW XP 1000
 NORTHSTAR PREMIUM



RANGER CREW XD 1500 PREMIUM



RANGER CREW XD 1500
 NORTHSTAR PREMIUM



RANGER CREW XD 1500
 NORTHSTAR ULTIMATE

FEATURES



MID-SIZE/CREW

RANGER SP 530



- 32 Horsepower
- 25" Carlisle 489 Tyres

RANGER SP 570 PREMIUM



PREMIUM TRIM ALSO INCLUDES:

- 44 Horsepower
- LED Headlights
- Full-Body Skid Plate
- Full-Coverage Front Bumper
- Electronic Power Steering (EPS)

RANGER 570 HD ADC



HD ADC TRIM ALSO INCLUDES:

- Engine Braking System & Active Descent Control (ADC)
- Hand Brake
- 25" Pro Armor X Terrain Tyres
- 25" Carlisle 489 Tyres

RANGER SP 570 NORTHSTAR



NORTHSTAR TRIM ALSO INCLUDES:

- Polaris HD 1,588KG Winch
- Factory Installed Heat
- Pro Shield Cab System with Manual Crank Window Doors
- USB Charge Port

COMMON SPECS



PROSTAR POLARIS ENGINE



ON-DEMAND TRUE ALL-WHEEL-DRIVE (AWD)



IRS WITH 25.4CM OF TRAVEL



VERSATRAC TURF MODE



680KG TOWING CAPACITY



DUMP BOX CAPACITY - 227KG

FEATURES



FULL-SIZE/CREW

RANGER 1000 EPS



1000 STANDARD FEATURES:

- 61 Horsepower
- 25" Carlisle Tyres
- Large Steel Bumper with Plow and Winch Integration

RANGER 1000 PREMIUM



PREMIUM TRIM ALSO INCLUDES:

- 26" PXT 2.0 Tyres
- 12" Aluminum Black Xcelerator Wheels
- Adjustable Seat Slider & LED Headlights
- Large Steel Bumper with Plow and Winch Integration

RANGER XP 1000 HD ADC



HD ADC TRIM ALSO INCLUDES:

- 82 Horsepower
- Engine Braking System & Active Descent Control (ADC)
- Hand Brake
- 27" Pro Armor X Terrain Tyres
- 3-Mode Throttle Control
- LED Headlights

*6-Seat does not include HD, Hand Brake and ADC Features.

RANGER XP 1000 NORTHSTAR PREMIUM



NORTHSTAR TRIM ALSO INCLUDES:

- Heating & Air Conditioning
- 2,041 KG HD Winch
- Pro Shield Cab System with Manual Crank Window Doors

COMMON SPECS



PROSTAR POLARIS ENGINE



HIGH PERFORMANCE ON-DEMAND TRUE AWD



ELECTRONIC POWER STEERING



VERSATRAC TURF MODE



1,134 KG TOWING CAPACITY



DUMP BOX CAPACITY - 454KG

DIESEL

RANGER DIESEL HD ADC



- 24.8 Horsepower
- Engine Braking System & Active Descent Control (ADC)
- Hand Brake
- Donaldson Air Filter
- 27" R12 Tyres

SPECS



PROSTAR POLARIS ENGINE



ON DEMAND TRUE ALL-WHEEL-DRIVE (AWD)



ELECTRONIC POWER STEERING



VERSATRAC TURF MODE



1,134KG TOWING CAPACITY



435KG DUMP BOX CAPACITY

ELECTRIC

RANGER XP KINETIC PREMIUM



PREMIUM TRIM INCLUDES:

- 14.9 KWh Lithium-Ion Battery with up to 70km* Estimate Range
- 3 KW On-Board Battery Charger
- 29" Pro Armor X-Terrain Tyres and 14" Wheels

RANGER XP KINETIC ULTIMATE



ULTIMATE TRIM ALSO INCLUDES:

- 29.8 KWh Lithium-Ion Battery with up to 130km* Estimate Range
- 6 KW On-Board Battery Charger

*Range estimates based on manufacturer data on typical customer driving usage and conditions. Actual range varies based on conditions such as external environment, weather, speed, cargo loads, rates of acceleration, vehicle maintenance, and vehicle usage.

COMMON SPECS



110 HORSEPOWER



HIGH PERFORMANCE ON DEMAND TRUE ALL-WHEEL DRIVE (AWD)



VERSATRAC TURF MODE



ELECTRONIC POWER STEERING



1,134 KG TOWING CAPACITY



567 KG DUMP BOX CAPACITY



12V CARGO BOX POWER PORT



LED HEADLIGHTS

FEATURES



EXTREME DUTY

RANGER XD 1500 PREMIUM



PREMIUM TRIM INCLUDES:

- Engine Braking System (EBS)
- Creep Function
- Steeldrive Transmission
- 29" Pro Armor X-Terrain & 14" Wheels
- High-Output LED Headlights
- Drive Modes: Comfort, Standard, Sport Tow/Haul
- Sport Roof + Line

RANGER XD 1500 NORTHSTAR PREMIUM



NORTHSTAR PREMIUM TRIM ALSO INCLUDES:

- 2,721 KG Pro HD Winch with Rapid Rope Recovery
- Enclosed Cab with Power Windows and Fixed Windshield
- Heating & Air Conditioning (HVAC) System
- 30" Kenda CrossTrail Tyres & 15" Wheels
- Electronic Cargo Box Lift
- LED Cargo Box Light and Overhead Switch Panel

RANGER XD 1500 NORTHSTAR ULTIMATE



NORTHSTAR ULTIMATE TRIM ALSO INCLUDES:

- Heated Seats
- JBL Trail Pro 2000 Audio
- 12V Cargo Box Power Port
- Tip Out Windshield

COMMON SPECS



110 HORSEPOWER



ON-DEMAND TRUE ALL-WHEEL-DRIVE (AWD)



ELECTRONIC POWER STEERING



VERSATRAC TURF MODE



1,588 KG TOWING CAPACITY



DUMP BOX CAPACITY - 680 KG



WORK HARD,
PLAY HARD



RANGER SP 530



RANGER 570 HD ADC



RANGER SP 570 PREMIUM



RANGER SP 570 NORTHSTAR

HORSEPOWER	32 HP	44 HP	44 HP	44 HP
DISPLACEMENT	567cc	567cc	567cc	567cc
DRIVE SYSTEM	On-Demand True AWD/2WD/VersaTrac Turf Mode	On-Demand True AWD/2WD/VersaTrac Turf Mode	On-Demand True AWD/2WD/VersaTrac Turf Mode	On-Demand True AWD/2WD/VersaTrac Turf Mode
ENGINE BRAKING SYSTEM / ACTIVE DESCENT CONTROL	Not Equipped / Not Equipped	Yes / Yes	Not Equipped / Not Equipped	Not Equipped / Not Equipped
FRONT SUSPENSION	MacPherson Strut 22.9 cm Travel	MacPherson Strut 22.9 cm Travel	MacPherson Strut 22.9 cm Travel	MacPherson Strut 22.9 cm Travel
REAR SUSPENSION	Dual A-Arm, IRS 25.4 cm Travel	Dual A-Arm, IRS 25.4 cm Travel	Dual A-Arm, IRS 25.4 cm Travel	Dual A-Arm, IRS 25.4 cm Travel
WHEELBASE	185.4 cm	185.4 cm	185.4 cm	185.4 cm
TYRES	25" Carlisle 489 (4 Ply Rated)	25" Carlisle 489 (4 Ply Rated)	25" Carlisle 489 (4 Ply Rated)	25" Carlisle Terra Cross (6 Ply Rated)
DRY WEIGHT	525 kg	499 kg	565 kg	681 kg
OVERALL VEHICLE SIZE (L X W X H)	279 x 147 x 185 cm	279 x 147 x 185 cm	274.3 x 142.2 x 188 cm	274.3 x 147.3 x 188 cm
GROUND CLEARANCE	27.9 cm	25.4 cm	27.9 cm	26.7 cm
SEATING CAPACITY	2	2	2	2
FUEL CAPACITY	35.9 L	34.1 L	35.9 L	35.9 L
TILT BOX CAPACITY	227 kg	227 kg	227 kg	227 kg
PAYLOAD CAPACITY	454 kg	454 kg	420 kg	318 kg
HITCH TOWING RATING	680 kg	680 kg	680 kg	680 kg
ELECTRONIC POWER STEERING	Not Equipped	Standard	Standard	Standard

*Specifications subject to change.



RANGER 1000 EPS



RANGER 1000 PREMIUM



RANGER XP 1000 HD ADC



RANGER DIESEL HD ADC



RANGER XP 1000 NORTHSTAR PREMIUM



RANGER XP KINETIC PREMIUM



RANGER XP KINETIC ULTIMATE

HORSEPOWER	61 HP	61 HP	82 HP	24.8 HP	82 HP	110 HP	110 HP
DISPLACEMENT	999cc	999cc	999cc	898cc	999cc	N.A.	N.A.
DRIVE SYSTEM	High Performance On-Demand True AWD/2WD/VersaTrac Turf Mode	High Performance On-Demand True AWD/2WD/VersaTrac Turf Mode	High Performance On-Demand True AWD/2WD/VersaTrac Turf Mode	On-Demand True AWD/2WD/Versatract Turf Mode	High Performance On-Demand True AWD/2WD/VersaTrac Turf Mode	High Performance On-Demand True AWD/2WD/VersaTrac Turf Mode	High Performance On-Demand True AWD/2WD/VersaTrac Turf Mode
ENGINE BRAKING SYSTEM / ACTIVE DESCENT CONTROL	Not Equipped / Not Equipped	Not Equipped / Not Equipped	Standard / Yes	Standard / Yes	Not Equipped / Not Equipped	Regenerative Braking / Not Equipped	Regenerative Braking / Not Equipped
FRONT SUSPENSION	Dual A-Arm, 25.4 cm Travel	Dual A-Arm, 25.4 cm Travel	Dual A-Arm 27.9 cm Travel	Dual A-Arm with Stabilizer Bar 27.9 cm Travel	Dual A-Arm 27.9 cm Travel	Dual A-Arm 25.4 cm Travel	Dual A-Arm 25.4 cm Travel
REAR SUSPENSION	Dual A-Arm, IRS 25.4 cm Travel	Dual A-Arm, IRS 25.4 cm Travel	Dual A-Arm, IRS 27.9 cm Travel	Dual A-Arm IRS with Stabilizer Bar 27.9 cm Travel	Dual A-Arm, IRS 27.9 cm Travel	Dual A-Arm, IRS 25.4 cm Travel	Dual A-Arm, IRS 25.4 cm Travel
WHEELBASE	206 cm	206 cm	206 cm	206 cm	206 cm	206 cm	206 cm
TYRES	25" Carlisle 489 (4 Ply Rated)	26" PXT 2.0 (6 Ply Rated)	27" Pro Armor X-Terrain (8 Ply Rated)	27" R12 (8 Ply Rated)	27" Pro Armor X-Terrain (8 Ply Rated)	29" Pro Armor X-Terrain (8 Ply Rated)	29" Pro Armor X-Terrain (8 Ply Rated)
DRY WEIGHT	673.6 kg	673.6 kg	737 kg	766 kg	867 kg	796 kg	899 kg
OVERALL VEHICLE SIZE (L X W X H)	305 x 158 x 193 cm	305 x 158 x 193 cm	305 x 158 x 196 cm	305 x 158 x 196 cm	305 x 165 x 198 cm	305 x 158 x 198 cm	305 x 158 x 198 cm
GROUND CLEARANCE	30.5 cm	31.8 cm	33 cm	33 cm	33 cm	35.6 cm	35.6 cm
SEATING CAPACITY	3	3	3	3	3	3	3
FUEL CAPACITY	43 L	43 L	43.5 L	43.5 L	43.5 L	14.9 kWh Lithium-Ion Battery with up to 70 km Estimate Range*	29.8 kWh Lithium-Ion Battery with up to 120 km Estimate Range*
TILT BOX CAPACITY	454 kg	454 kg	454 kg	435 kg	454 kg	567 kg	567 kg
PAYLOAD CAPACITY	680 kg	680 kg	680 kg	720 kg	578 kg	680 kg	680 kg
HITCH TOWING RATING	1,134 kg	1,134 kg	1,134 kg	1,134 kg	1,134 kg	1,134 kg	1,134 kg
ELECTRONIC POWER STEERING	Standard	Standard	Standard	Standard	Standard	Standard	Standard

*Specifications subject to change. Range estimates based on manufacturer data on typical customer driving usage and conditions. Actual range varies based on conditions such as external environment, weather, speed, cargo loads, rates of acceleration, vehicle maintenance, and vehicle usage.

POLARIS RANGER

CREW | COMFORTABLE SEATING FOR 4-6



RANGER CREW SP 570 PREMIUM



RANGER CREW 1000 PREMIUM



**RANGER CREW XP
1000 PREMIUM**



**RANGER CREW XP 1000
NORTHSTAR PREMIUM**

HORSEPOWER	44 HP	61 HP	82 HP	82 HP
DISPLACEMENT	567 cc	999cc	999cc	999cc
DRIVE SYSTEM	On-Demand True AWD/2WD/VersaTrac Turf Mode	High Performance On-Demand True AWD/2WD/VersaTrac Turf Mode	High Performance On-Demand True AWD/2WD/VersaTrac Turf Mode	High Performance On-Demand True AWD/2WD/VersaTrac Turf Mode
ENGINE BRAKING SYSTEM / ACTIVE DESCENT CONTROL	Not Equipped / Not Equipped	Not Equipped/ Not Equipped	Not Equipped/ Not Equipped	Not Equipped/ Not Equipped
FRONT SUSPENSION	MacPherson Strut 22.9 cm Travel	Dual A-Arm 25.4 cm Travel	Dual A-Arm 27.9 cm Travel	Dual A-Arm 27.9 cm Travel
REAR SUSPENSION	Dual A-Arm, IRS 25.4 cm Travel	Dual A-Arm, IRS 25.4 cm Travel	Dual A-Arm, IRS 27.9 cm Travel	Dual A-Arm, IRS 27.9 cm Travel
WHEELBASE	266.7 cm	287 cm	287 cm	287 cm
TYRES	25" Carlisle 489 (4 Ply Rated)	26" PXT 2.0 (6 Ply Rated)	27" Pro Armor X-Terrain (8 Ply Rated)	27" Pro Armor X Terrain (8 Ply Rated)
DRY WEIGHT	703 kg	814 kg	859 kg	1,083 kg
OVERALL VEHICLE SIZE (L X W X H)	365.8 x 142.2 x 188 cm	386 x 158 x 193 cm	386 x 158 x 196 cm	386 x 165 x 198 cm
GROUND CLEARANCE	27.9 cm	31.8 cm	33 cm	33 cm
SEATING CAPACITY	4	6	6	6
FUEL CAPACITY	35.9 L	43 L	43.5 L	43.5 L
TILT BOX CAPACITY	226.8 kg	454 kg	454 kg	454 kg
PAYLOAD CAPACITY	499 kg	794 kg	767 kg	558 kg
HITCH TOWING RATING	680 kg	1,134 kg	1,134 kg	1,134 kg
ELECTRONIC POWER STEERING	Standard	Standard	Standard	Standard

*Specifications subject to change.

POLARIS



RANGER XD 1500 PREMIUM



RANGER XD 1500 NORTHSTAR PREMIUM



RANGER XD 1500 NORTHSTAR ULTIMATE



RANGER CREW XD 1500 PREMIUM



RANGER CREW XD 1500 NORTHSTAR PREMIUM



RANGER CREW XD 1500 NORTHSTAR ULTIMATE

HORSEPOWER	110 HP	110 HP	110 HP	110 HP	110 HP	110 HP
DISPLACEMENT	1498cc	1498cc	1498cc	1498cc	1498cc	1498cc
DRIVE SYSTEM	On-Demand True AWD/2WD/Turf/Ultra Turf, Drive Modes: Comfort, Standard, Sport, Tow/Haul, Equipped with creep in drive and reverse to help with low speed drivability for smoother power delivery	On-Demand True AWD/2WD/Turf/Ultra Turf, Drive Modes: Comfort, Standard, Sport, Tow/Haul, Equipped with creep in drive and reverse to help with low speed drivability for smoother power delivery	On-Demand True AWD/2WD/Turf/Ultra Turf, Drive Modes: Comfort, Standard, Sport, Tow/Haul, Equipped with creep in drive and reverse to help with low speed drivability for smoother power delivery	On-Demand True AWD/2WD/Turf/Ultra Turf, Drive Modes: Comfort, Standard, Sport, Tow/Haul, Equipped with creep in drive and reverse to help with low speed drivability for smoother power delivery	On-Demand True AWD/2WD/Turf/Ultra Turf, Drive Modes: Comfort, Standard, Sport, Tow/Haul, Equipped with creep in drive and reverse to help with low speed drivability for smoother power delivery	On-Demand True AWD/2WD/Turf/Ultra Turf, Drive Modes: Comfort, Standard, Sport, Tow/Haul, Equipped with creep in drive and reverse to help with low speed drivability for smoother power delivery
ENGINE BRAKING SYSTEM / ACTIVE DESCENT CONTROL	Drive Mode Specific Engine Braking System. Hill Assist enables the vehicle to hold its position, allowing easier maneuvering and improved control when stopping and starting on hills.	Drive Mode Specific Engine Braking System. Hill Assist enables the vehicle to hold its position, allowing easier maneuvering and improved control when stopping and starting on hills.	Drive Mode Specific Engine Braking System. Hill Assist enables the vehicle to hold its position, allowing easier maneuvering and improved control when stopping and starting on hills.	Drive Mode Specific Engine Braking System. Hill Assist enables the vehicle to hold its position, allowing easier maneuvering and improved control when stopping and starting on hills.	Drive Mode Specific Engine Braking System. Hill Assist enables the vehicle to hold its position, allowing easier maneuvering and improved control when stopping and starting on hills.	Drive Mode Specific Engine Braking System. Hill Assist enables the vehicle to hold its position, allowing easier maneuvering and improved control when stopping and starting on hills.
FRONT SUSPENSION	Dual A-Arm 30.5 cm Travel	Dual A-Arm 30.5 cm Travel	Dual A-Arm 30.5 cm Travel	Dual A-Arm 30.5 cm Travel	Dual A-Arm 30.5 cm Travel	Dual A-Arm 30.5 cm Travel
REAR SUSPENSION	Dual Arched A-Arm IRS 30.5 cm Travel	Dual Arched A-Arm IRS 30.5 cm Travel	Dual Arched A-Arm IRS 30.5 cm Travel	Dual Arched A-Arm IRS 30.5 cm Travel	Dual Arched A-Arm IRS 30.5 cm Travel	Dual Arched A-Arm IRS 30.5 cm Travel
WHEELBASE	241.3 cm	241.3 cm	241.3 cm	322.6 cm	322.6 cm	322.6 cm
TYRES	29" Pro Armor X-Terrain (8 Ply Rated)	30" KENDA® CROSS TRAIL (8 Ply Rated)	30" KENDA® CROSS TRAIL (8 Ply Rated)	29" Pro Armor X-Terrain (8 Ply Rated)	30" KENDA® CROSS TRAIL (8 Ply Rated)	30" KENDA® CROSS TRAIL (8 Ply Rated)
DRY WEIGHT	1,122 kg	1,270 kg	1,270 kg	1,318 kg	1,507 kg	1,507 kg
OVERALL VEHICLE SIZE (L X W X H)	348 x 163 x 198 cm	348 x 163 x 198 cm	348 x 163 x 198 cm	416.5 x 163 x 198 cm	416.5 x 163 x 198 cm	416.5 x 163 x 198 cm
GROUND CLEARANCE	38 cm	38 cm	38 cm	38 cm	38 cm	38 cm
SEATING CAPACITY	3	3	3	6	6	6
FUEL CAPACITY	51.5 L	51.5 L	51.5 L	51.5 L	51.5 L	51.5 L
TILT BOX CAPACITY	680 kg	680 kg	680 kg	680 kg	680 kg	680 kg
PAYLOAD CAPACITY	957 kg	773 kg	773 kg	975 kg	755 kg	755 kg
HITCH TOWING RATING	1,588 kg	1,588 kg	1,588 kg	1,588 kg	1,588 kg	1,588 kg
ELECTRONIC POWER STEERING	High Output EPS	High Output EPS	High Output EPS	High Output EPS	High Output EPS	High Output EPS

*Specifications subject to change.

INTRODUCING THE NEW RANGER XD 1500

RANGER XD 1500

WINDSHIELDS
& REAR PANELS

DOORS

CAB COMFORT
& CONVENIENCE

WINCHES

PROTECTION

AUDIO

STORAGE

WINDSHIELDS & REAR PANELS

GLASS vs HARD COAT POLY

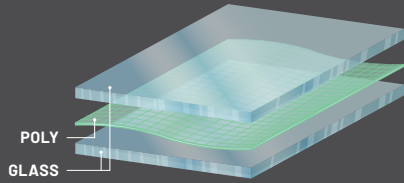

Superior optical clarity (automotive level)
 Scratch-resistant
 Curved to fit, seals tight
 Cold weather / heavy duty
 Wiper ready

Lightweight, flexible, easy to store/remove
 Impact-resistant
 Tight seal keeps out rain and dust
 30x more scratch-resistant

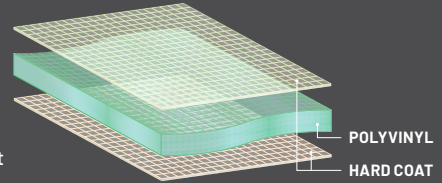

POLARIS ENGINEERED ADVANTAGES



LOCK & RIDE
 REVOLUTIONARY INSTALLATION

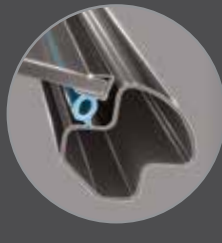

AIRTIGHT GASKET SEAL



VENTING OPTIONS



MULTI-FUNCTION FEATURES

WINDSHIELDS



TIP-OUT GLASS WINDSHIELD UPGRADE KIT

- Components needed to convert a fixed glass windshield into a tip-out windshield
- Includes center handle, base, gas struts and hardware
- Windshield not included

» 2889085

XD 1500 '24, CREW XD 1500 '24
 REQUIRES FIXED GLASS WINDSHIELD (2889086), SOLD SEPARATELY
 NOT COMPATIBLE WITH POLY WINDSHIELDS



FIXED GLASS WINDSHIELD

- Durable automotive glass and perfectly sealed design
- Superior clarity and toughness while shielding you from every form of weather

» 2889086

XD 1500 '24, CREW XD 1500 '24



LOCK & RIDE HARD COAT POLY FULL WINDSHIELD - VENTED

- Frameless design for maximum crystal clear visibility
- Vents at the bottom of windshield allow for adjustable airflow on a hot day or defrost on a cold day
- Lock & Ride technology for quick and easy on and off
- Fits perfectly into the ROPs with a 360° gasket seal

» 2889089

XD 1500 '24, CREW XD 1500 '24
 NOT COMPATIBLE WITH TIP-OUT GLASS WINDSHIELD UPGRADE KIT (2889085)



LOCK & RIDE HARD COAT POLY FULL WINDSHIELD

- Frameless design for maximum crystal clear visibility
- Lock & Ride technology for quick and easy on and off
- Fits perfectly into the ROPs with a 360° gasket seal

» 2889088

XD 1500 '24, CREW XD 1500 '24
 NOT COMPATIBLE WITH TIP-OUT GLASS WINDSHIELD UPGRADE KIT (2889085)



LOCK & RIDE HARD COAT POLY HALF WINDSHIELD

- Seals at the base for reliable protection from the elements and off-road hazards
- Provides airflow for an open-air riding experience

» 2889090

XD 1500 '24, CREW XD 1500 '24

REAR PANEL



LOCK & RIDE GLASS REAR PANEL

- Seal out the elements such as dust swirl, rain and snow
- Dramatically reduce unwanted cab noise

» 2889092

XD 1500 '24, CREW XD 1500 '24

DOORS



RANGER XD 1500

WINDSHIELDS
& REAR PANELS

DOORS

CAB COMFORT
& CONVENIENCE

WINCHES

PROTECTION

AUDIO

STORAGE



**PREMIUM
FEATURES**



**UNPRECEDENTED
VENTILATION OPTIONS**



**EASY & FAST
INSTALLATION**

POLARIS ENGINEERED ADVANTAGES



FULL POWER DOORS

- Fit perfectly into the ROPs with predesignated mounting locations
- Sure-closing, tight sealing 360° gasket seal at the ROPs, and the glass windows can be adjusted infinitely with the dash-mounted switches
- Rear hinging, for easy ingress and egress
- The tubular steel frame lines laminate safety glass that blocks UV rays and is strengthened by an interlayer of polyvinyl butyral (PVB)
- Come with interior and exterior door handles, power windows, and a built-in storage compartment

» FRONT • 2889075

» REAR • 2889076

XD 1500 '24, CREW XD 1500 '24

REQUIRES EXTERIOR DOOR ACCENT PANELS, SOLD SEPARATELY



EXTERIOR DOOR ACCENT PANELS

- Install factory color-matched accent panels that complement your vehicle's color
- Clear coated for UV protection and installs easily with a single screw into the door jam
- Accent panels are required to complete the Full Power Doors

» FRONT • 2890688

» REAR • 2890689

XD 1500 '24, CREW XD 1500 '24
REQUIRES FULL POWER DOORS,
SOLD SEPARATELY

CAB COMFORT & CONVENIENCE



LATE AVAILABILITY

HEATER KIT



- 8-vent heater and defrost system
- Easily control the climate inside your cab in any season
- Helps defrost windshields and keep you warm or cool
- Three different fan speeds
- Heat and fan dash-mounted controls
- Manual vents

» 3-SEAT (SHOWN) • 2889745

XD 1500 '24, CREW XD 1500 '24

» CREW • 2890011

XD 1500 '24, CREW XD 1500 '24

REQUIRES 3-SEAT HEATER KIT (2889745), SOLD SEPARATELY



LATE AVAILABILITY

SUN VISOR

- Injection molded visor that flips down to reduce sun glare in early morning or at dusk
- Can be mounted on passenger or drivers side

» 2890571

XD 1500 '24, CREW XD 1500 '24



DOME LIGHT KIT

- Easy install LED dome light provides optimal visibility inside your cab

» 2889097

XD 1500 '24, CREW XD 1500 '24



AUXILIARY LIGHTS - FRONT BRUSHGUARD

- Bumper mounted accent lights provide additional front illumination
- Integrated into bumper pockets for a seamless fit
- Dash mounted switch

» 2889767

XD 1500 '24, CREW XD 1500 '24



CONVEX REARVIEW MIRROR

- Get a panoramic view of the trail and any obstacles behind your ORV
- Durable cast aluminum construction ensures the mirror stays attached through your roughest off-road adventures

» 2889096

XD 1500 '24, CREW XD 1500 '24



SIDE VIEW MIRRORS

- Fully adjustable to accommodate riders of all sizes and can fold in to prevent being struck

» DOOR MOUNTED • 2889862

XD 1500 '24, CREW XD 1500 '24

REQUIRES FULL POWER DOORS OR GLASS/POLY WINDSHIELD. EACH SOLD SEPARATELY

» ROPS-MOUNTED (SHOWN) • 2889099

XD 1500 '24, CREW XD 1500 '24

NOT COMPATIBLE WITH FULL POWER DOORS OR WINDSHIELDS

DOME LIGHT - STANDALONE

- Dome light allows for in cab visibility in low light
- Standalone kit connects to front PULSE bar location

» 2890423

XD 1500 '24, CREW XD 1500 '24



OVERHEAD SWITCH PANEL KIT

- Add up to 4 additional electrical accessory switches conveniently overhead with this roof-mounted upper switch panel

» 2890422

XD 1500 '24, CREW XD 1500 '24

12V CARGO BOX POWER PORT

- Power your tools or accessories to get the job done
- Dash mounted switch allows you to turn a sprayer or spreader on or off from the cab

» 2890857

XD 1500 '24, CREW XD 1500 '24



WINDSHIELD WIPER & WASHER KIT

- Designed to fit with full-height, glass windshields
- Mounts seamlessly due to the integrated mounting and wire routing locations
- Included washer tank mounts under the front hood and all electrical and sprayer lines route within the ROPS cage integrated channel
- Dash mounted rocker switch controls the wiper and sprayer independently

» 2889095

XD 1500 '24, CREW XD 1500 '24

NOT COMPATIBLE WITH POLY WINDSHIELDS

PULSE KIT - ROOF MOUNTED

- Add additional electrical capacity to power all of your favorite Polaris accessories

» 3-SEAT • 2890262

XD 1500 '24

» CREW • 2890441

CREW XD 1500 '24



HORN KIT

- Powered by the vehicle's own electrical power
- Strong blast will safely alert those nearby
- Includes horn, mounting hardware and actuator

» 2889098

XD 1500 '24, CREW XD 1500 '24



REAR WORK LIGHT

- Mounts to the back of your cab to fully illuminate the cargo box and surrounding area
- Includes mounting hardware
- Integrated into roof for a clean look

» 2889771

XD 1500 '24, CREW XD 1500 '24

PREMIUM MODELS REQUIRE OVERHEAD SWITCH PANEL (2890422) AND REAR PULSE KIT (PART NUMBERS VARY), EACH SOLD SEPARATELY

WINCHES



FEATURES & BENEFITS

PRO PRO HEAVY DUTY SERIES

HD HEAVY DUTY SERIES

RAPID ROPE RECOVERY

Retrieve cable 5x as fast as standard mode on other Polaris winches. Get back to riding or complete your task quicker.



NOT AVAILABLE

AUTO STOP TECHNOLOGY

Auto Stop technology protects and extends the life of your winch by automatically stopping the winch at the end of pull to prevent over-spooling.



ADD AUTO STOP UPGRADE
+ WIRELESS REMOTE
2890991
SYNTHETIC ROPE REQUIRED

WIRELESS REMOTE

Operate your winch wirelessly from within 50 ft of the vehicle.

PREMIUM SYNTHETIC ROPE

Lightweight, extremely strong and flexible 50 ft long rope stands up to any tough job.



MODEL

2,722 KG

2,041 KG

XD 1500 '24
CREW XD 1500 '24

2889276

2889275

UPGRADE YOUR CONTROLS HD OR PRO HD WINCHES

POWER CONTROLLER

- Control your winch and plow hydraulics directly from the shift knob

» 2889769

XD 1500 '24, CREW XD 1500 '24



REPLACEMENT PARTS

SYNTHETIC ROPE

» 2,722 KG
2879188

» 2,041 KG
2879187



PROTECTION



UPPER FRONT BRUSHGUARD

- 1.75" tube steel construction
- Protects the front of your ride, including your headlights
- Mounts by bolting onto the stock front bumper
- Does not impede the headlights or winch and plow attachments
- Scratch-resistant, black powder-coated finish
- Used as attachment structure for hood rack

» 2884872

XD 1500 '24, CREW XD 1500 '24



REAR BRUSHGUARD

- Built to take on the toughest terrain with dependable strength, safely protecting tailgate and taillights
- Mounted to ensure rear clearance, your wheels can still move even when the cargo bed is tipped back fully
- Integrated mounting holes for easy installation
- Black powder-coated finish
- Compatible with tow hitches

» 2884876

XD 1500 '24, CREW XD 1500 '24



ROCKGUARD WITH STEP

- The sturdy, steel construction includes a black e-coat and a durable, black powder-coated finish
- Easily get into the vehicle, and remove mud from footwear with an integrated boot scraper
- Easily installs with integrated mounting locations directly on the frame, instead of underneath, for maximum ground clearance

» 2-SEAT (SHOWN) • 2884874

XD 1500 '24

» CREW • 2884875

CREW XD 1500 '24



FRONT BUMPER BULL BAR

- Steel upper hoop that attaches to stock bumper and adds additional protection to front of vehicle

» 2890855

XD 1500 '24, CREW XD 1500 '24



SHACKLES - HD BRUSHGUARD

- Bumper mounted tow hooks that can be used to secure vehicle to a trailer or used as an easy hook up point when towing an object

» 2890854

XD 1500 '24, CREW XD 1500 '24

AUDIO



JBL has brought music to life in a way people can feel for over 70 years. From iconic concerts to the world's biggest sporting events, the award-winning sound has powered the world's most epic musicians, athletes and venues. Unleash the power of music so you can live life to the fullest wherever and whenever.

JBL® partnered with Polaris to create the highest performing audio system, specifically designed for RANGER. Purpose-built to stand up to any outdoor environment and developed to deliver on your next adventure.

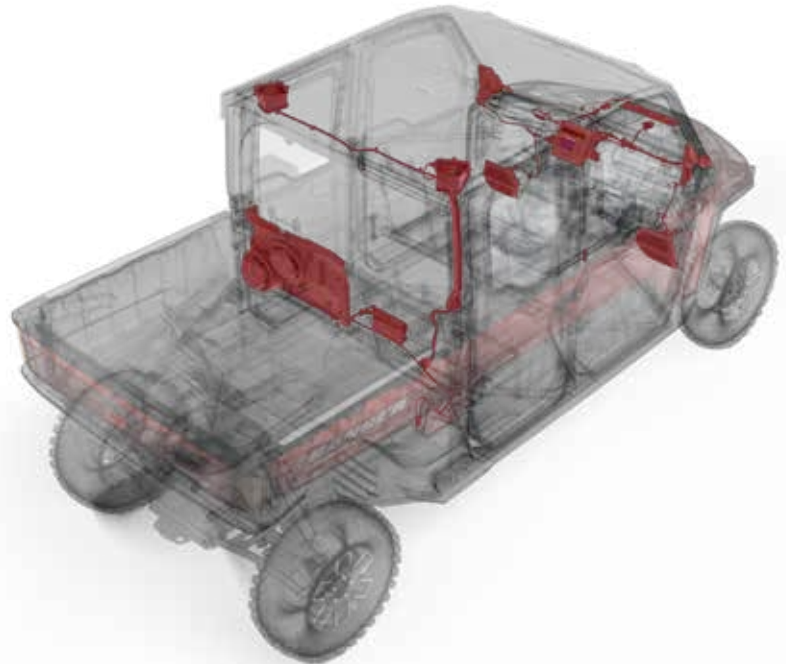

JBL® TRAIL PRO 2000 AUDIO KIT

- 25 Watt x 4 channel internal amplifier
- 4.3" color TFT screen
- Bluetooth® 4.2
- AM/FM/WB tuner
- Two 50 Watt tweeters
- Two 75 Watt 6.5" speakers

» 2889762

XD 1500 '24, CREW XD 1500 '24



JBL® TRAIL PRO 4200 AUDIO UPGRADE KIT

- Two 40 Watt 4" speakers
- 40 Watt x 4 channel amplifier
- Two 8" subwoofers with 300 Watt amplifier

» 2889763

XD 1500 '24, CREW XD 1500 '24

REQUIRES JBL® TRAIL PRO 2000 AUDIO KIT (2889762) OR RIDE COMMAND, EACH SOLD SEPARATELY

STORAGE SOLUTIONS FOR EVERY JOB

Equip your RANGER with Polaris Engineered storage accessories to pack all your essentials for every job. The versatile lineup includes all-new, easy-to-install patented Lock & Ride MAX accessories – like a utility rack, spare tyre carrier and rear storage box – that offer limitless ways to customize your vehicle’s storage capabilities.



Plus, we’ve partnered with Rhino-Rack® to deliver premium roof and bed rack solutions. Transform your vehicle for work, play or anything in between with these easy to use racks, load securing accessories and the latest in carrier technology. These racks deliver increased storage capacity, allowing you to elevate your pursuit and get more done in a day.



INTRODUCING



This vehicle features an all-new accessory system built around the need for next level durability and adaptability.

Our next generation of Polaris Lock & Ride technology brings with it an entirely new system of purpose-built accessories and attachments. This means you can configure your vehicle for any job, work more efficiently and get more done than ever before.

With virtually endless configurations and no tools required, you have the freedom to easily reconfigure on the fly and spend more time getting the job done.



RANGER X-D 1500

WINDSHIELDS & REAR PANELS

DOORS

CAB COMFORT & CONVENIENCE

WINCHES

PROTECTION

AUDIO

STORAGE

HOW IT WORKS



1. Choose accessories



2. Position on the vehicle

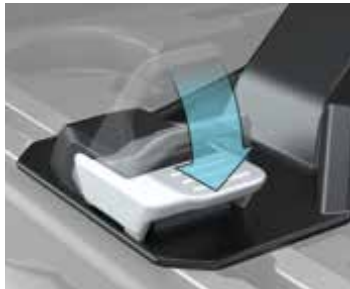

3. Lock accessories into place

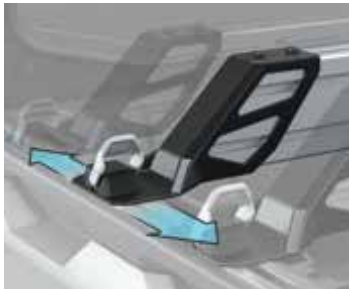

4. Reconfigure as needed

STORAGE



LR LOCK & RIDE MAX
SPARE TYRE CARRIER

- Attaches to bed rails or cross bed rail
- Allows user to securely carry a spare tyre up to 32 inches in diameter

» 2889110
XD 1500 '24, CREW XD 1500 '24



LR LOCK & RIDE MAX
CROSS BED RAIL

- Provides additional mounting options with Lock & Ride MAX accessories
- Can be used as a divider in the vehicle bed
- Quick, toolless install with Lock & Ride MAX slide locks

» 2889800
XD 1500 '24, CREW XD 1500 '24



LR LOCK & RIDE MAX
BED EXTENDER/DIVIDER

- Add 30% more cargo space with the rear gate lowered and the extender installed
- Can also be turned around as a divider in box to keep items from moving over bumpy terrain

» 2889109
XD 1500 '24, CREW XD 1500 '24



REAR HEADACHE RACK - WINCH READY

- Mounts to rear ROPs of vehicle
- Expanded metal screen allows rear visibility and protects rear panel from damage
- Used to mount rear mounted winch

» 2889666
XD 1500 '24, CREW XD 1500 '24



LR LOCK & RIDE MAX
STORAGE BOX

- Attaches to bed rails with Lock & Ride MAX technology and can be positioned anywhere in the bed
- Large enough to hold helmets and other large items
- Dustproof and waterproof with 360° seals on all openings

» 2889108
XD 1500 '24, CREW XD 1500 '24



LR LOCK & RIDE
FRONT HOOD STORAGE RACK

- Durable, steel-constructed rack with powder-coated finish mounts across the hood for additional UTV storage, up to 100 lbs.
- Helps protect your vehicle from brush and debris
- Easy installation with Lock & Ride technology
- Integrated side rails easily pivot to access the underhood

» 2884878
XD 1500 '24, CREW XD 1500 '24
REQUIRES UPPER FRONT BRUSHGUARD (2884872), SOLD SEPARATELY



MODULAR CARGO SYSTEM (MCS)

- Overbed structure that bolts to Lock & Ride Max rails and allows user to add the Tool Rack, Tool Extension, Rear Bed Rack and/or Stronghold Auto Latch Mounts, to offer additional storage solutions

» 2889847
XD 1500 '24, CREW XD 1500 '24



RAILS - MCS/HEADACHE RACK

- Additional accessory rails that can be attached to either the Headache Rack, or to the interior of the Lock & Ride MAX Utility Rack

» 2890444
XD 1500 '24, CREW XD 1500 '24
REQUIRES UTILITY RACK (2889847) OR REAR HEADACHE RACK - WINCH READY (2889666), EACH SOLD SEPARATELY



CHAINSAW MOUNT

- Attaches to bed rails or cross bed rail and allows user to securely carry a chainsaw

» 2889105
XD 1500 '24, CREW XD 1500 '24

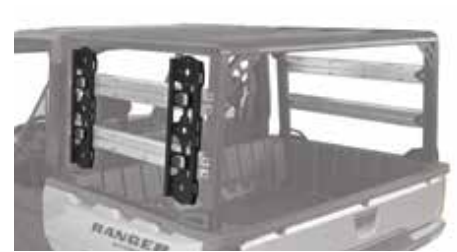

MCS TOOL RACK

- Attaches to Utility Rack with Lock & Ride MAX attachments, providing ability to carry long handled equipment like shovels and rakes

» 2889846
XD 1500 '24, CREW XD 1500 '24
REQUIRES UTILITY RACK (2889847) AND RAILS - MCS/HEADACHE RACK (2890444), EACH SOLD SEPARATELY



MCS TOOL RACK EXTENSIONS

- Attaches to Utility Rack and allows user to carry hoses and other items

» 2889911
XD 1500 '24, CREW XD 1500 '24
REQUIRES UTILITY RACK (2889847) AND RAILS - MCS/HEADACHE RACK (2890444), EACH SOLD SEPARATELY



REAR HYDRAULIC BED LIFT

- Electric hydraulic bed lift allows for easy dumping of the bed, even when at full capacity
- Dash switch controlled

» 2889768
XD 1500 '24, CREW XD 1500 '24



GUN MOUNTING BRACKET

- Attaches to Utility Rack and allows user to attach any Kolpin Stronghold Auto Latch items

» 2889931
XD 1500 '24, CREW XD 1500 '24

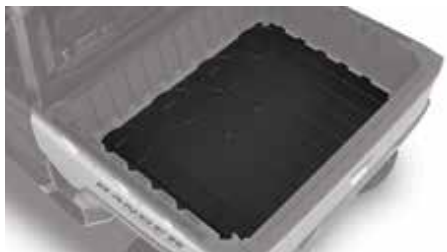

CARGO BED MAT

- Thick 0.2" molded poly mat looks good, protects the box, reduces unwanted drivetrain noise and keeps cargo more secure with a non-slip design

» 2889106
XD 1500 '24, CREW XD 1500 '24



FRONT RECEIVER HITCH

- 2" front receiver allows attachment of a trailer hitch for easily backing trailers into tight locations
- Bolts to vehicle frame

» 2889657
XD 1500 '24, CREW XD 1500 '24



1,000 LB. REAR CARGO BOX WINCH

- 1,000 lb. pull force winch that mounts to Headache Rack
- Allows for easy loading of big game or other large and heavy items in the bed

» 2889698
XD 1500 '24, CREW XD 1500 '24

WINDSHIELDS & REAR PANELS

DOORS

CAB COMFORT & CONVENIENCE

WINCHES

PROTECTION

AUDIO

STORAGE

RANGER XD 1500

STORAGE



BRING IT ALL. BRING IT ON.

From opposite sides of the globe, some of the most capable machines in the off-road world meet a trusted outdoor adventure brand to deliver industry-exclusive, purpose-built roof racks, bed racks and attachments that help RANGER riders get the job done.



RANGER XD 1500

WINDSHIELDS & REAR PANELS

DOORS

CAB COMFORT & CONVENIENCE

WINCHES

PROTECTION

AUDIO

STORAGE

PICK YOUR RACK



ROOF RACKS

- Bring everything you need
- Sleek, durable backbone and innovative attachment system ensures secure attachment to your vehicle

» 3-SEAT • 2889236
XD 1500 '24

» CREW (SHOWN) • 2889237
CREW XD 1500 '24



REAR BED RACK

- Ultimate modular load carrying solution
- Strong, lightweight aluminum construction tested in the harshest conditions
- Outfit with a wide variety of Rhino-Rack® accessories to customize your set up
- Mounts to the bed of your vehicle
- Weight capacity on bed - 150 lbs.

» 2889860
XD 1500 '24, CREW XD 1500 '24
REQUIRES RHINO-RACK® REAR BED RACK MOUNT (2889860), SOLD SEPARATELY
NOT COMPATIBLE WITH UTILITY RACK (2889847)

PICK YOUR MOUNT



REAR BED RACK MOUNT

» 2889844
XD 1500 '24, CREW XD 1500 '24



ROOF RACK MOUNT

» 3-SEAT • 2889103
XD 1500 '24, CREW XD 1500 '24

» CREW • 2889104
XD 1500 '24, CREW XD 1500 '24

ACCESSORIZE IT

WINDSHIELDS & REAR PANELS

DOORS

CAB COMFORT & CONVENIENCE

WINCHES

PROTECTION

AUDIO

STORAGE



SPARE TYRE HOLDER

- Transport a spare tyre outside the vehicle
- Easily mounts to the Rhino-Rack Rear Bed Rack (2889590), sold separately

» 2889529

XD 1500 '24, CREW XD 1500 '24



HIGH-LIFTING JACK MOUNT

- Simple, quick install with durable brackets
- Rugged, non-corrosive powder-coated steel stands up to the harshest conditions

» 2889533

XD 1500 '24, CREW XD 1500 '24



FISHING ROD HOLDER

- Convenient, locking carrier can transport five fishing rods safely and securely on a roof rack
- Doubles as a ski/snowboard carrier

» 2889729

XD 1500 '24, CREW XD 1500 '24



200 L LUGGAGE BAG

- Carry bulky, lightweight gear in this tear- and weather-resistant canvas bag

» 2889881

XD 1500 '24, CREW XD 1500 '24



J-STYLE KAYAK HOLDER

- Transport a kayak or canoe on the roof of your vehicle

» 2889883

XD 1500 '24, CREW XD 1500 '24

REQUIRES ACCESSORY BARS (2889884), SOLD SEPARATELY



ACCESSORY BARS

- Offers horizontal fitment to allow other accessories to be attached to the Rhino-Rack® platforms

» 2889884

XD 1500 '24, CREW XD 1500 '24

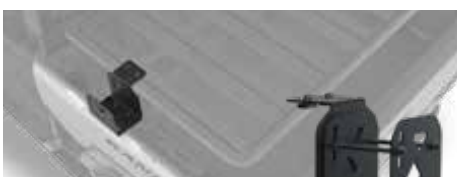

GUN MOUNTING BRACKET

- Mount Kolpin Stronghold Gun Boots to Rhino-Rack systems when paired with Auto-Latch Mount (2636942), sold separately

» 2889327

XD 1500 '24, CREW XD 1500 '24

See P. 86 for more hunt information



EYELET TIE-DOWNS

- Attach in multiple locations on the platform for additional tie-down points
- Anti-corrosive, galvanized steel for heavy duty strength
- Includes one set with hardware (straps not included)

» 2889527

XD 1500 '24, CREW XD 1500 '24

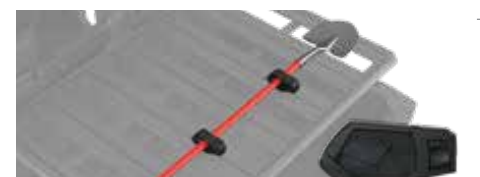

MULTI-PURPOSE TOOL HOLDER

- Carry and protect tools, paddles and more
- Ratchet-locking mechanism for quick release and rubber inserts that secure gear into place

» 2889528

XD 1500 '24, CREW XD 1500 '24



TRACTION BOARD MOUNTS

- Strong, durable and easy to attach
- Traction boards sold separately

» 2889530

XD 1500 '24, CREW XD 1500 '24



CARGO CORNER BRACKETS

- Mount a NorthStar cooler or toolbox to the platform and save space inside the vehicle (straps not included)
- A unique, anti-rotation nut offers maximum security

» 2889531

XD 1500 '24, CREW XD 1500 '24

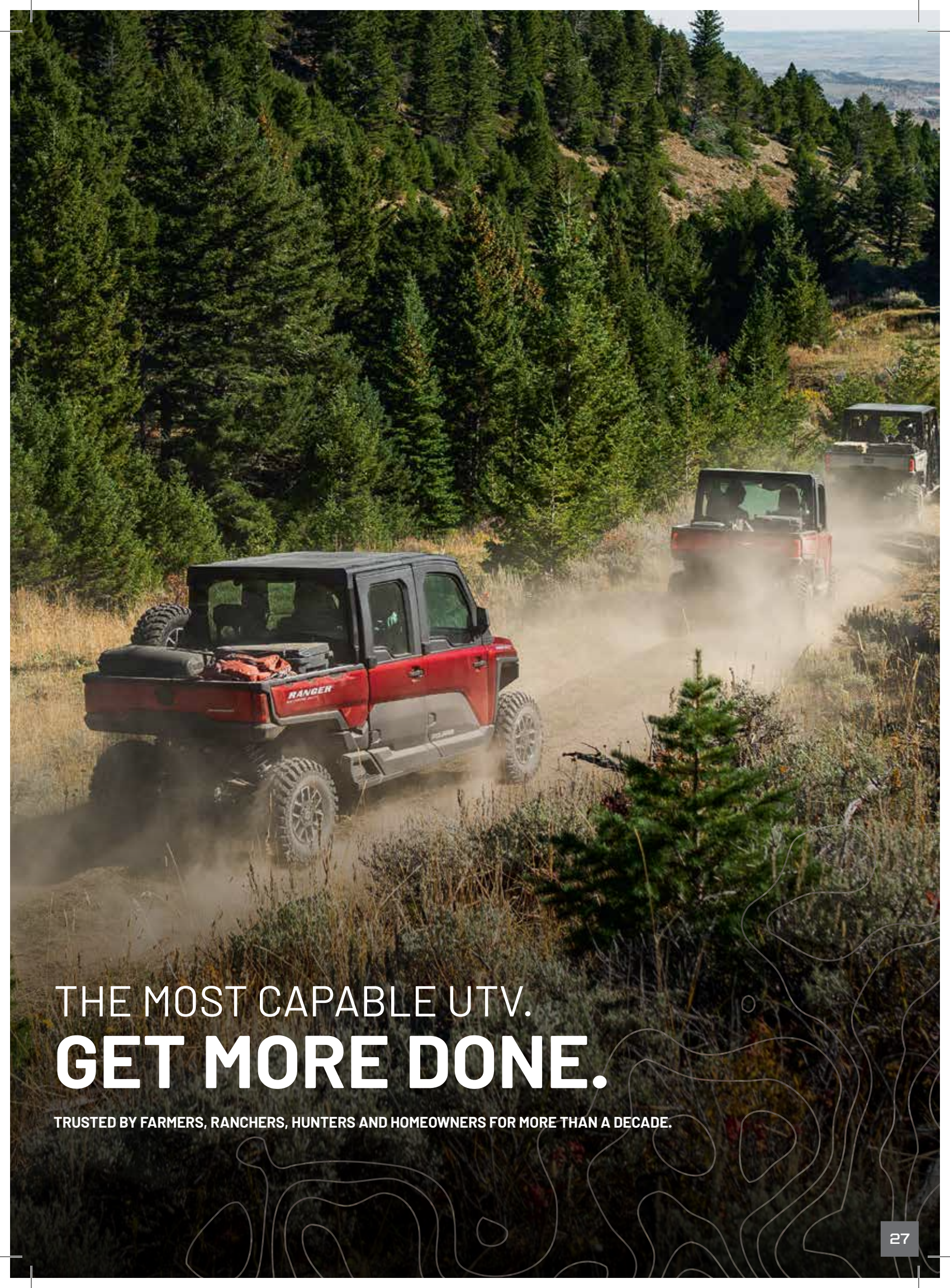

THE MOST CAPABLE UTV.
GET MORE DONE.

TRUSTED BY FARMERS, RANCHERS, HUNTERS AND HOMEOWNERS FOR MORE THAN A DECADE.

RANGER XP KINETIC THE POWER TO DO MORE

DO MORE THAN EVER BEFORE with the full-size electric RANGER. Unmatched horsepower and instant torque means more power than ever before to precisely pull, haul more, and get more done. The industry's strongest drivetrain delivers lower maintenance costs and more uptime to get the job done. Plus, the quiet electric powertrain enables easy conversations while riding and stealthy trips to hunting spots.



1000 / XP 1000 / XP KINETIC

ROOFS

WINDSHIELDS
& REAR PANELS

DOORS

CAB COMFORT
& CONVENIENCE

WINCHES

PROTECTION

AUDIO

STORAGE



RIDE COMMAND FRONT CAMERA

- Provides additional vantage point
- Front-mounted camera to help with plowing and other tasks

» 2889662

XP KINETIC '23-24



ACCESSORY BUMPER HARDWARE

- Required when using a front camera as well as an upper front bumper or hood rack

» 2889659

XP KINETIC '23-24



IN-CAB HEATER AND DEFROST KIT

- Instant heat, no more waiting for engine to warm up
- Easily control the climate inside your cab in any season
- Helps defrost windshields and keep you warm or cool
- Three different fan speeds
- Heat and fan dash-mounted controls
- Manual vents

» 2889449

XP KINETIC '23-24

REQUIRES HIGH VOLTAGE BUSBAR (2889667), SOLD SEPARATELY



HIGH VOLTAGE BUSBAR

- Required for adding heater or other high voltage accessories such as upgraded chargers

» 2889667

XP KINETIC '23-24

ROOFS

TO SHIELD AGAINST DRIVING RAIN OR THE BLISTERING SUN, a roof is the first must-have of the Polaris Engineered cab components. Get on your way with protective peace of mind.

POLY FEATURES

- Water run-off
- Liner ready
- Polaris PULSE plug and play
- Lightweight

POLARIS ENGINEERED ADVANTAGES



PREMIUM FINISH AND QUIETER RIDE

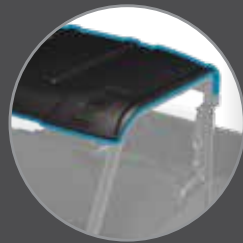

SEALED COVERAGE

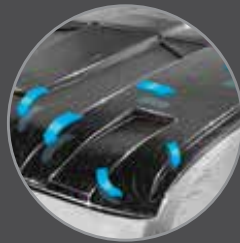

REDUCE STANDING WATER



EASY AND FAST INSTALLATION

PREMIUM & SPORT ROOF FEATURES

SEE AUDIO OPTIONS P. 52
ADD POWER TO PREMIUM & SPORT ROOFS P. 80



MULTI-FUNCTION LIGHT READY

WINDSHIELD WIPER & WASHER SYSTEM WIRING READY

POLARIS PULSE INTEGRATION

AUDIO READY

SOUND ABSORBING LINER

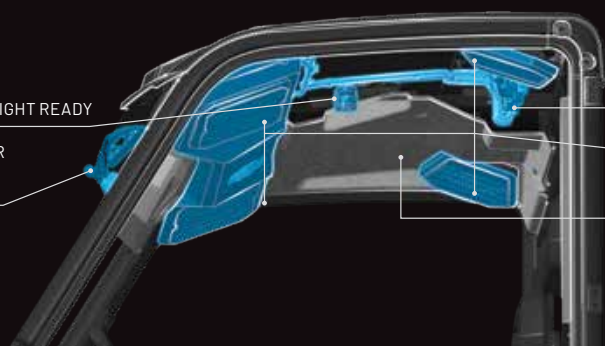

* Premium and Sport features not available on steel roofs

POLY

Lightweight, durable and impact-resistant. A poly roof can take the abuse of a tough trail and still protect.

SPORT ROOF - POLY TOP SELLER

» BLACK • 2882911

XP 1000 '17-24, 1000 '20-24, XP KINETIC '23-24



SPORT ROOF CREW - POLY TOP SELLER

» BLACK • 2889223

CREW XP 1000 '19-24, CREW 1000 '20-24



LINERS

Get a touch of premium comfort, reduce cab noise and hide wiring. Included with Premium Poly Roofs.

PREMIUM ROOF LINER

» 2882914

XP 1000 '17-24, 1000 '20-24, XP KINETIC '23-24
WORKS WITH 2882911, 2882912, 2882913



PREMIUM ROOF LINER - CREW TOP SELLER

» 2883457

CREW XP 1000 '18-24, CREW 1000 '20-24



WINDSHIELDS & REAR PANELS

GLASS vs HARD COAT POLY

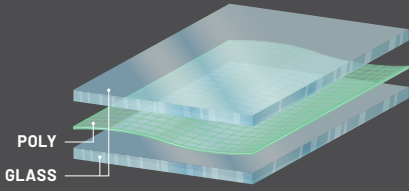

POLY
GLASS

Superior optical clarity (automotive level)
Scratch-resistant
Curved to fit, seals tight
Cold weather / heavy duty
Wiper ready

Lightweight, flexible, easy to store/remove
Impact-resistant
360° seal keeps out rain and dust

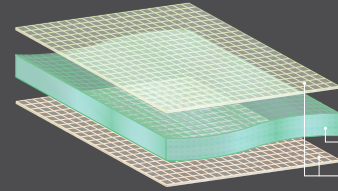

POLYVINYL
HARD COAT



OPEN

PRO SHIELD
CAB SYSTEM

TIP-OUT FULL WINDSHIELD - GLASS

- Tip-out design offers three positions: open, closed and vented
- Gas shocks assist in easy opening and closing
- 360° gasket for reliable protection and comfort
- Scratch-resistant automotive-style curved glass

» 2889020

XP 1000 '18-24, CREW XP 1000 '19-24, CREW 1000 '20-24, 1000 '20-24, XP KINETIC '23-24



PRO SHIELD
CAB SYSTEM

FULL GLASS WINDSHIELD - CLEAR

- Scratch-resistant, curved laminate safety glass
- Protects against wind, rain and other debris
- UV-blocking interlayer and 360° gasket seal

» 2889021

XP 1000 '18-24, CREW XP 1000 '19-24, CREW 1000 '20-24, 1000 '20-24, XP KINETIC '23-24



WIPER AVAILABLE
P. 46

PRO SHIELD
CAB SYSTEM

FULL WINDSHIELD VENTED - HARD COAT POLY TOP SELLER

- Frameless design for maximum visibility
- Added vents for airflow on a hot day or defrosting on a cold day
- Requires Wiper Install Kit (2207624), sold separately

» 2883266

XP 1000 '17-24, CREW XP 1000 '18-24, CREW 1000 '20-24, 1000 '20-24, XP KINETIC '23-24



WIPER AVAILABLE
P. 46

PRO SHIELD
CAB SYSTEM

FULL WINDSHIELD - HARD COAT POLY TOP SELLER

- Frameless design for maximum visibility
- Requires Wiper Install Kit (2207624), sold separately

» 2883300

XP 1000 '17-24, CREW XP 1000 '18-24, CREW 1000 '20-24, 1000 '20-24, XP KINETIC '23-24



OPEN

PRO SHIELD
CAB SYSTEM

FLIP-DOWN WINDSHIELD - HARD COAT POLY TOP SELLER

- Two venting options: fully sealed, flip-down or remove upper half for some protection with maximum ventilation

» 2884139

XP 1000 '18-24, CREW XP 1000 '19-24, CREW 1000 '20-24, 1000 '20-24, XP KINETIC '23-24

1000 / XP 1000 / XP KINETIC

ROOFS

WINDSHIELDS & REAR PANELS

DOORS

CAB COMFORT & CONVENIENCE

WINCHES

PROTECTION

AUDIO

STORAGE



POLARIS ENGINEERED ADVANTAGES



EASY AND FAST INSTALLATION



AIRTIGHT GASKET SEAL



MULTI-FUNCTION FEATURES



PRO SHIELD CAB SYSTEM



FULL WINDSHIELD - POLY TOP SELLER

- Frameless design for maximum visibility

» 2883278

XP 1000 '17-24, CREW XP 1000 '18-24, CREW 1000 '20-24, 1000 '20-24, XP KINETIC '23-24



HALF WINDSHIELD - POLY TOP SELLER

- Deflects air flow from straight on, but still provides air flow in the cab

» 2883301

XP 1000 '17-24, CREW XP 1000 '18-24, CREW 1000 '20-24, 1000 '20-24, XP KINETIC '23-24



ADD ALL-WEATHER VISIBILITY

P. 46

REAR PANELS



PRO SHIELD CAB SYSTEM



REAR PANEL - SLIDING GLASS

- Sliding window provides ventilation, cab comfort and access to cargo in rear box

» 2879015

XP 1000 '17-24, CREW XP 1000 '18-24, CREW 1000 '20-24, 1000 '20-24, XP KINETIC '23-24



PRO SHIELD CAB SYSTEM



REAR PANEL - GLASS TOP SELLER

» 2879013

XP 1000 '17-24, CREW XP 1000 '18-24, CREW 1000 '20-24, 1000 '20-24, XP KINETIC '23-24



PRO SHIELD CAB SYSTEM



REAR PANEL - POLY TOP SELLER

- Strong, thick polycarbonate provides outstanding impact and scratch resistance
- Installs in contours of cab frame with 360° gasketing for outstanding protection, comfort, fit and finish

» 2883773

XP 1000 '17-24, CREW XP 1000 '18-24, CREW 1000 '20-24, 1000 '20-24, XP KINETIC '23-24



REDUCE IN-CAB DUST SWIRL BY ADDING A REAR PANEL.

With a windshield and roof installed, turbulent air develops behind the cab. Add a rear panel to reduce dust intrusion from this swirl.

ROOFS

WINDSHIELDS & REAR PANELS

DOORS

CAB COMFORT & CONVENIENCE

WINCHES

PROTECTION

AUDIO

STORAGE

DOORS

KEY FEATURES

- PRO SHIELD CAB SYSTEM
- WINDOW TYPE / VENTILATION
- VISIBILITY
- STORAGE COMPARTMENT
- AUDIO-READY / SPEAKER MOUNT
- PREMIUM TPE LINER
- SPECIAL FEATURES

PREMIUM POLY DOORS		
POWER WINDOW DOORS	MANUAL CRANK WINDOW DOORS	HALF DOORS
GLASS / POWER	GLASS / MANUAL CRANK	NA / OPEN TOP
UPPER	UPPER	UPPER
STANDARD	STANDARD	STANDARD
STANDARD, PRE-WIRED	STANDARD	
STANDARD	STANDARD	STANDARD
BUILT-IN FLOOR LIGHT, COLORED ACCENT PANELS AVAILABLE	COLORED ACCENT PANELS AVAILABLE	COLORED ACCENT PANELS AVAILABLE
<ul style="list-style-type: none"> The ultimate door offering power windows, switches mounted on the door and built-in floor light. 	<ul style="list-style-type: none"> A premium, door offering manual crank windows for airflow adjustment in the cab. 	<ul style="list-style-type: none"> Provides lower protection from the off-road with an open-air experience.

Front and Rear Doors of same design are required to complete a cab on CREW Ranger models.

ROOFS

WINDSHIELDS & REAR PANELS

DOORS

CAB COMPART & CONVENIENCE

WINCHES

PROTECTION

AUDIO

STORAGE



GET SUPERIOR PERFORMANCE AND OUR BEST SEAL with the Pro Shield Cab System door line



- 360° GASKET SEAL
- EASY TO CLEAN TPE LINER
- BUILT-IN STORAGE
- AUDIO-READY
- VENTILATION OPTIONS

FRONT DOORS (SET OF 2) <small>XP 1000 19-24, CREW XP 1000 19-24, CREW 1000 20-24, XP KINETIC 23-24</small>	 POWER WINDOW DOORS - POLY - BLACK 2889813	 MANUAL CRANK WINDOW DOORS - POLY - BLACK 2889811	 HALF DOORS - POLY 2889814
	REAR DOORS (SET OF 2) <small>CREW XP 1000 19-24, CREW 1000 20-24</small>	 MANUAL CRANK WINDOW DOORS - REAR - POLY 2889812	 HALF DOORS - REAR - POLY 2889815

EXTERIOR DOOR ACCENT PANELS

- Replace stock gloss black accent panels
- Painted plastic and clear-coated for UV protection
- Install easily with a single screw
- Comes as a pair

	SUPER GRAPHITE		AZURE CRYSTAL		BRONSON ROCK
FRONT 2882870-509		2882870-809		2882870-755	
REAR 2883829-509		2883829-809		2883829-755	
	SOLAR RED		BLACK PEARL		MATTE SUNSET RED
FRONT 2883499-342		2882870-666		2882870-669	
REAR --		--		--	
	STEEL BLUE		GHOST WHITE METALLIC		POLARIS BLUE
FRONT 2882870-765		2882870-774		2882870-795	
REAR 2883829-765		2883829-774		2883829-795	

POLY DOORS		CANVAS DOORS
RANGER HUNTER DOORS	RANGER CLEARVIEW DOORS	ZIP WINDOW DOORS
		
GLASS / HINGED	GLASS / HINGED	CLEAR POLY / ZIPPED
UPPER	UPPER + LOWER	UPPER + PARTIAL LOWER
DURABLE POLY CONSTRUCTION, POLARIS PURSUIT CAMO	DURABLE POLY CONSTRUCTION	AVAILABLE IN POLARIS PURSUIT CAMO
<ul style="list-style-type: none"> Tough clear poly shell extends from the bottom of the door until it meets the upper-hinged glass window. Premium Polaris Pursuit Camo pattern offers extensive camo coverage. 	<ul style="list-style-type: none"> Deliver nearly uninterrupted visibility and maximum ambient lighting inside the cab. Tough clear poly shell extends from the bottom of the door until it meets the upper-hinged glass window. 	<ul style="list-style-type: none"> Lightweight, durable protection with adjustable zipper ventilation and see-through bottom panel.

Premium Doors come with Gloss Black Exterior Door Accent Panels, images shown with optional Exterior Door Accent Panels.

 <p> RANGER HUNTER DOORS - POLARIS PURSUIT CAMO 2883229</p>	 <p> RANGER CLEARVIEW DOORS 2882901</p>	 <p>TOP SELLER ZIP WINDOW DOORS - CANVAS - BLACK 2882902</p>  <p>ZIP WINDOW DOORS - CANVAS - POLARIS PURSUIT CAMO 2882903</p>
	 <p> RANGER CLEARVIEW DOORS - REAR 2883632</p>	 <p>ZIP WINDOW DOORS - REAR - CANVAS - BLACK 2883634</p>

 **SPRINGFIELD BLUE**
2882870-640
2883829-640

 **WHITE LIGHTENING**
2882870-599
2883829-599

 **POLARIS PURSUIT CAMO**
2882870-587
2883829-587

 **PEARL WHITE**
2882870-566
--

 **MATTE SAGEBRUSH GREEN**
2882870-685
2883829-685

 **SUNSET RED METALLIC**
2882870-520
2883829-520

 **MATTE NAVY**
2882870-726
2883829-726

 **BURGUNDY METALLIC**
2882870-629
--

 **STEALTH GRAY**
2882870-804
2883829-804

 **ONYX BLACK**
2882870-866
--

 **ICY WHITE PEARL**
2882870-911
--



REQUIRED POLARIS PULSE INSTALLATION ITEMS

CAB COMFORT & CONVENIENCE

UNDER SEAT DRY STORAGE **XP 1000 ONLY**

» 2882910

XP 1000 '18-24, CREW XP 1000 '19-24, XP KINETIC '23-24
WILL NOT WORK WITH SUBWOOFER 2882890 & 2884233



8-VENT HEATER & DEFROST SYSTEM

TOP SELLER



- Easily control the climate inside your cab in any season
- Helps defrost windshields and keeps you warm or cool
- Heat and fan dash-mounted controls
- Manual vents

» 2882753 **XP 1000 ONLY**

XP 1000 '18-24, CREW XP 1000 '19-24

» 2884066 **1000 ONLY**

CREW 1000 '20-24, 1000 '20-24
NEED ADAPTER: 2884163 ON CREW 1000

» CREW HEATER ADAPTER KIT **1000 ONLY**
2884163

CREW 1000 '20-24



WINDSHIELD WIPER & WASHER SYSTEM

TOP SELLER



» 2883974

XP 1000 '18-24, CREW XP 1000 '19-24,
CREW 1000 '20-24, 1000 '20-24, XP KINETIC '23-24
POLY WINDSHIELDS REQUIRE MOUNT KIT (2207624), SOLD SEPARATELY

HARD COAT POLY WINDSHIELD WIPER & WASHER SYSTEM MOUNTING BRACKET

» 2207624

XP 1000 '17-24, CREW XP 1000 '18-24,
CREW 1000 '20-24, 1000 '20-24, XP KINETIC '23-24
REQUIRED TO USE WIPER ON POLY WINDSHIELDS (2883266 OR 2883300)



FLOOR MATS - 3 SEAT

» 2882780 **XP 1000 ONLY**

XP 1000 '18-24, CREW XP 1000 '19-24, XP KINETIC '23-24
CREW: FITS FRONT SEATS ONLY

» 2884247 **1000 ONLY**

CREW 1000 '20-24, 1000 '20-24
CREW: FITS FRONT SEATS ONLY

NOISE REDUCTION SYSTEM

- Designed to attach to the rear closure panel of your RANGER cab
- The sound absorbing material reduces unwanted noise for a quieter cab

» 2883489

XP 1000 '18-24, CREW XP 1000 '19-24,
1000 '20-24, CREW 1000 '20-24, XP KINETIC '23-24



IN-CAB HEATER AND DEFROST KIT

- Easily control the climate inside your cab in any season
- Helps defrost windshields and keep you warm or cool
- Three different fan speeds
- Heat and fan dash-mounted controls
- Manual vents

» 2889449

XP KINETIC '23-24
REQUIRES HIGH VOLTAGE BUSBAR (2889667), SOLD SEPARATELY



12V CARGO BED POWER KIT*

- Additional power for your tools or accessories
- Requires 12V In-Bed Power Harness Extension (2890068), sold separately

» 2889673

XP 1000 '18-24, CREW XP 1000 '18-24, 1000 '20-24, CREW 1000 '20-24
REQUIRES 12V IN-BED POWER HARNESS EXTENSION (2890068), SOLD SEPARATELY



12V IN-BED POWER HARNESS EXTENSION*

- Required for Installation of 12V Cargo Bed Power Kit (2889673)

» 2890068

CREW XP 1000 '18-24, CREW 1000 '20-24



UPPER SWITCH PANEL *

- Add up to 4 additional electrical accessory switches
- Convenient roof-mounted overhead panel
- Includes mounting hardware

» 2889674

XP 1000 '18-24, CREW XP 1000 '18-24, 1000 '20-24, CREW 1000 '20-24
REQUIRES UPPER SWITCH PANEL LIGHT BAR HARNESS (2889675), SOLD SEPARATELY



SIDE VIEW MIRRORS

- Mounts on any RANGER vehicle that is equipped with doors
- Fully adjustable to accommodate riders of all sizes and can fold in to prevent being struck

» DOOR MOUNTED • 2889241

» ROPS-MOUNTED (SHOWN) • 2889243

XP 1000 '18-24, CREW XP 1000 '19-24, CREW 1000 '20-24,
1000 '20-24, XP KINETIC '23-24

NOT COMPATIBLE WITH TIP-OUT WINDSHIELD (2889020), DOORS OR UNITS WITH A FORWARD GRIP HANDLE ON THE ROPS



LARGE REAR VIEW MIRROR **TOP SELLER**

» 2879969

XP 1000 '17-24, CREW XP 1000 '18-24, CREW 1000 '20-24,
1000 '20-24, XP KINETIC '23-24



WIDE ANGLE REAR VIEW MIRROR

- Large 6.4 x 35.6 cm adjustable convex mirrored surface gives you a full-spectrum view

» 2881439

XP 1000 '17-24, CREW XP 1000 '18-24, CREW 1000 '20-24,
1000 '20-24, XP KINETIC '23-24



NEW LATE AVAILABILITY

SUN VISOR

- Injection molded visors for seamless fit to protection from the sun

» 2890288

XP 1000 '17-24, CREW XP 1000 '18-24, CREW 1000 '20-24,
1000 '20-24, XP KINETIC '23-24

CAB COMFORT & CONVENIENCE

1000 / XP 1000 / XP KINETIC

ROOFS

WINDSHIELDS & REAR PANELS

DOORS

CAB COMFORT & CONVENIENCE

WINCHES

PROTECTION

AUDIO

STORAGE

WORK BEACON LED LIGHT

- 15.2 m of illumination 360° around your vehicle
- Ideal for plowing, hunting and nighttime utility work
- Break-away construction protects the light in areas with tight clearance
- Mounted to the vehicle on the rear of the ROPS
- Easily hinge the light up during use and hinge it down when in transit
- Add LED Headlights for more light

» 2883265

XP 1000 '18-24, CREW XP 1000 '19-24, CREW 1000 '20-24, 1000 '20-24, XP KINETIC '23-24

REQUIRES LIGHT BAR HARNESS/EXTENSION (2883230 AND 2883854), EACH SOLD SEPARATELY



REAR LED WORK LIGHT

- Mounts to the back of your cab to fully illuminate the cargo box and surrounding area
- Includes necessary mounting hardware
- Requires a harness

» 2889672

XP 1000 '18-24, CREW XP 1000 '18-24, 1000 '20-24, CREW 1000 '20-24

CREW: REQUIRE HARNESS (2889675) AND HARNESS EXTENSION (2890067), EACH SOLD SEPARATELY



LED HEADLIGHTS XP 1000 ONLY

- LED Headlights offer improved brightness and illumination vs stock halogen lights
- Designed with styling specific to RANGER

» 2889072

XP 1000 '18-24, CREW XP 1000 '19-24, XP KINETIC '23-24



MULTI-FUNCTION CAB LIGHT

- LED dome light provides white, red, green and blue lighting options
- Battery-operated. Recharges when the vehicle is on
- Can be removed to use as a flashlight in and around your vehicle

» 2882871

XP 1000 '18-24, CREW XP 1000 '19-24, CREW 1000 '20-24, 1000 '20-24, XP KINETIC '23-24
REQUIRES POLARIS PULSE ROOF 6 (2882904), SOLD SEPARATELY



- Red light is great for reading maps
- Green light is perfect for navigating in the dark
- Blue light is ideal for night riding

WINCHES

1000 / XP 1000 / XP KINETIC

ROOFS

WINDSHIELDS
& REAR PANELS

DOORS

CAB COMFORT
& CONVENIENCE

WINCHES

PROTECTION

AUDIO

STORAGE

FEATURES & BENEFITS

PRO PRO HEAVY DUTY SERIES

HD HEAVY DUTY SERIES

RAPID ROPE RECOVERY

Retrieve cable 5x as fast as standard mode on other Polaris winches. Get back to riding or complete your task quicker.



NOT AVAILABLE

AUTO STOP TECHNOLOGY

Auto Stop technology protects and extends the life of your winch by automatically stopping the winch at the end of pull to prevent over-spooling.



ADD AUTO STOP UPGRADE
2883454
SYNTHETIC ROPE REQUIRED

PREMIUM SYNTHETIC ROPE

Lightweight, extremely strong and flexible 50 ft long rope stands up to any tough job.



ADD SYNTHETIC ROPE
2879187

WIRELESS REMOTE

Operate your winch wirelessly from within 50 ft of the vehicle.



TOP SELLER
ADD WIRELESS REMOTE
2883455



MODEL

2,722 KG

2,041 KG

2,041 KG

XP 1000/CREW XP 1000 '19-24
1000/CREW 1000 '20-24
XP KINETIC '23-24

NON EPS RANGER 1000 REQUIRES FRONT BUMPER

TOP SELLER
2882710

TOP SELLER
2882711
High-Mounted
2889272

TOP SELLER
2882714

UPGRADE YOUR CONTROLS HD OR PRO HD WINCHES

DASH WINCH SWITCH KIT

- Allows user to add a dash switch as an additional means to control winch
- Can be used with all winches and are compatible with other control methods (wireless/wired)

» 2889050

XP 1000 '18-24, CREW XP 1000 '19-24, CREW 1000 '20-24, 1000 '20-24, XP KINETIC '23-24

TOP SELLER

POWER CONTROLLER

- Control your winch and plow hydraulics directly from the shift knob

» 2883247

XP 1000 '18-24, CREW XP 1000 '19-24, CREW 1000 '20-24, 1000 '20-24, XP KINETIC '23-24

REQUIRES WINCH ADAPTER (2884159), SOLD SEPARATELY, WHEN USING A WINCH FOR LIFTING DEVICE



WIRED REMOTE CONTROL

- Must order remote handle and socket together

» REMOTE HANDLE • 4013466

» SOCKET • 4017102

REPLACEMENT PARTS

SYNTHETIC ROPE

» 2,041 KG • 2879187

» 2,722 KG • 2879188



PROTECTION

1000 / XP 1000 / XP KINETIC

FRONT

INSTALLS DIRECTLY TO STOCK BUMPER

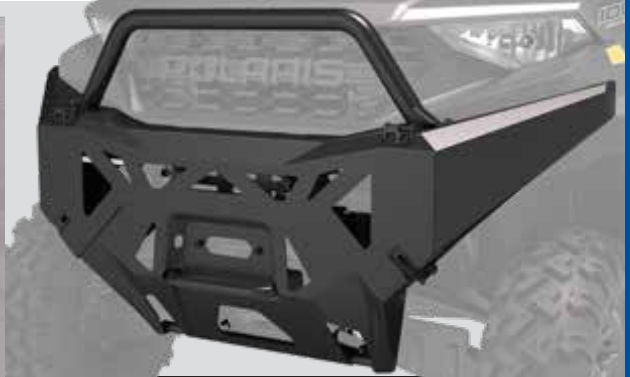

4.4 CM DIAMETER STEEL TUBE CONSTRUCTION

REAR



CAN BE USED IN CONJUNCTION WITH A TOW HITCH



ROOFS

STANDARD BRUSHGUARDS TOP SELLER

- To use Front Bumper with RIDE COMMAND and Front Camera, RIDE COMMAND Bumper Adapter (2207941) is required

» FRONT • 2882531

» REAR • 2882529

XP 1000 '18-24, CREW XP 1000 '19-24, CREW 1000 '20-24, 1000 '20-24, XP KINETIC '23-24
FRONT BRUSHGUARD DOES NOT FIT HIGH LIFTER MODELS
1000 NON-EPS VEHICLES REQUIRE FRONT BUMPER: 2884123

» RIDE COMMAND BUMPER ADAPTER • 2207941

FOR USE ON VEHICLES WITH RIDE COMMAND AND FRONT CAMERA

HD BRUSHGUARDS

- Increased protection over stock bumper with integrated mounting locations for accessories and lights (sold separately) with a durable matte black finish
- Easy installation with included mounting hardware
- Additional 36" storage area for recovery equipment

» FRONT • 2885105

» REAR • 2884217

XP 1000 '18-24, CREW XP 1000 '19-24, CREW 1000 '20-24, 1000 '20-24, XP KINETIC '23-24
FRONT BRUSHGUARD DOES NOT FIT HIGH LIFTER MODELS
REAR: RECOMMENDED WITH RIGID OR PRO ARMOR
POD LIGHTS FOR UPGRADED LIGHTING

WINDSHIELDS & REAR PANELS

DOORS

ROCK GUARDS

ROCK GUARD WITH STEP

- Reliable, hard-working protection for edges of vehicle
- Integrated step with boot scraper helps keep interior clean
- Mounts directly to the frame, instead of underneath, for maximum ground clearance
- Steel construction with black e-coat and durable black powder-coated finish

» TOP SELLER 3-SEAT • 2882530

» CREW • 2883398

XP 1000 '18-24, 1000 '20-24, XP KINETIC '23-24

CREW XP 1000 '19-24, CREW 1000 '20-24



3-SEAT



CREW

MUD GUARDS

NEW MUD GUARDS

- Attaches under the bed to protect underside of bed, engine components and under seat area of vehicle from mud build up
- Allows for easier vehicle cleaning and less debris build up

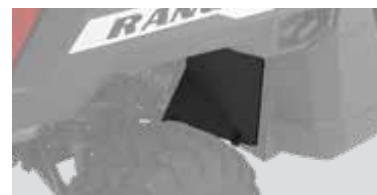

» RANGER 1000
2889639

1000 '20-24, CREW 1000 '20-24



» RANGER XP 1000
NORTHSTAR EDITION
2889689

'18-24 XP 1000 NORTHSTAR,
'19-24 CREW XP 1000 NORTHSTAR



» RANGER XP 1000
2889640

'18-24 XP 1000,
'19-24 CREW XP 1000

CAB COMFORT & CONVENIENCE

WINCHES

PROTECTION

AUDIO

STORAGE



HIGH-MOUNTED FRONT BRUSHGUARD

- Increased protection over stock bumper
- Offers a higher winch mounting position which allows for easier access when used in deep mud
- Not compatible with Polaris Plow Systems

» 2889271

XP 1000 '18-24, CREW XP 1000 '19-24, CREW 1000 '20-24, 1000 '20-24, XP KINETIC '23-24

HIGH-MOUNTED HD 2,041 KG WINCH (2889272), SOLD SEPARATELY, RECOMMENDED WHEN BRUSHGUARD IS INSTALLED

FRONT BRUSHGUARD 1000 ONLY

- Increased protection over stock bumper
- Sturdy stamped steel and tube construction
- Integrated mounting positions for plow and winch accessories

» 2889330

CREW 1000 '20-24, 1000 '20-24
REQUIRED TO INSTALL WINCH/PLOW ON NON EPS RANGER 1000

HIGH-MOUNTED HD 2,041 KG WINCH

- Provides outstanding performance and versatile pulling power
- The elevated mounting position allows for easier access when used in deep mud

» 2889272

XP 1000 '18-24, CREW XP 1000 '19-24, CREW 1000 '20-21, 1000 '20-24, XP KINETIC '23-24



ACCESSORY BUMPER HARDWARE

- Required when using a front camera as well as an upper front bumper or hood rack

» 2889659

XP KINETIC '23-24



A-ARMS



HIGH CLEARANCE A-ARMS

- Valuable, reliable protection for vital front suspension components exposed to the rigors of off-road environments
- Strong, durable, lightweight polyethylene construction withstands off-road impacts to protect the A-Arms

» FRONT • 2889269

XP 1000 '18-24, CREW XP 1000 '19-24, CREW 1000 '20-24, 1000 '20-24, XP KINETIC '23-24

» REAR • 2889270

XP 1000 '18-24, CREW XP 1000 '19-24, CREW 1000 '20-24, 1000 '20-24, XP KINETIC '23-24

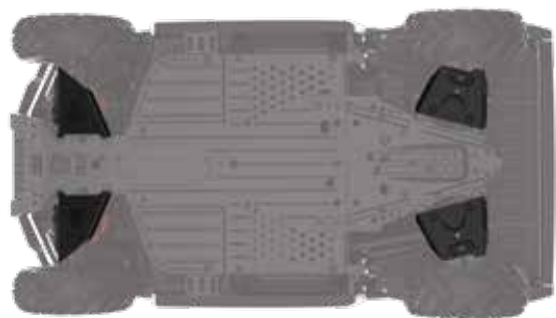

HMW A-ARM GUARDS

- Strong, .64 cm thick, durable, lightweight HMW (high molecular weight) polyethylene construction helps protect against off-road impacts
- Molded specifically for the RANGER XP 1000 & 1000 front suspension for a sure fit and low-profile presence
- Easy bolt-on design with mounting hardware included

» FRONT • 2882784

XP 1000 '18-20, CREW XP 1000 '19-20, CREW 1000 '20, 1000 '20
WILL NOT FIT ARCHED A-ARM MODELS

» REAR • 2882787

XP 1000 '18-24, CREW XP 1000 '19-24, CREW 1000 '20-24, 1000 '20-24, XP KINETIC '23-24
WILL NOT FIT ARCHED A-ARM MODELS

AUDIO

1000 / XP 1000 / XP KINETIC

ROOFS

WINDSHIELDS
& REAR PANELS

DOORS

CAB COMFORT
& CONVENIENCE

WINCHES

PROTECTION

AUDIO

STORAGE



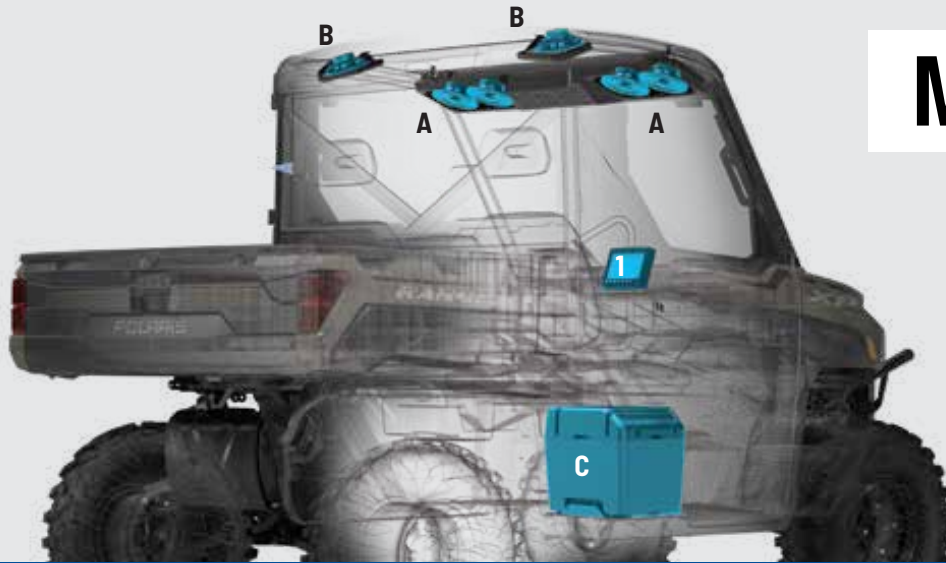

BUILD YOUR SOUND WITH RIDE COMMAND

STEP 1

ADD HEAD UNIT

7" DISPLAY POWERED BY RIDE COMMAND*

2884072

SEE P. 78 FOR MORE INFORMATION

STEP 2

ADD MOUNT

2889309

XP 1000 '22-24, CREW XP 1000 '22-24,
CREW 1000 '22-24, 1000 '22-24,
XP KINETIC '23-24
FOR NORTHSTAR AND ALL OTHER MODELS
WITHOUT 900 WATT

OR

2889310

XP 1000 '22-24, CREW XP
1000 '22-24, CREW 1000
'22-24, 1000 '22-24,
XP KINETIC '23-24
FOR 900 WATT STATOR

STEP 3

UPGRADE AUDIO BY ADDING VISOR OR DASH AUDIO

OPTION 1 VISOR AUDIO

A. OVERHEAD VISOR SPEAKERS

2882891

HARNESS REQUIRED

TOP SELLER 2882904

CREW MODELS REQUIRE
ADDITIONAL 2883231

B. REAR OVERHEAD SPEAKERS

TOP SELLER 2882876

XP 1000 '18-24, CREW XP 1000 '19-24, CREW 1000 '20-24,
1000 '20-24, XP KINETIC '23-24

+

C. 25.4 CM MAXBOOST SUBWOOFER

2884233

XP 1000 '18-24, CREW XP 1000 '19-24, XP KINETIC '23-24
WITH 900 WATT STATOR
NOT COMPATIBLE WITH UNDER SEAT DRY STORAGE
(2882910) INSTALLED

OR

AUDIO DASH SPEAKERS

TOP SELLER 2883956

XP 1000 '19-24, CREW XP 1000 '19-24,
CREW 1000 '20-24, 1000 '20-24,
XP KINETIC '23-24

B. REAR OVERHEAD SPEAKERS

TOP SELLER 2882876

XP 1000 '18-24, CREW XP 1000 '19-24, CREW 1000 '20-24,
1000 '20-24, XP KINETIC '23-24

+

C. 25.4 CM MAXBOOST SUBWOOFER

2884233

XP 1000 '18-24, CREW XP 1000 '19-24, XP KINETIC '23-24
RANGER MODELS WITH RIDE COMMAND PACKAGE REQUIRE
ADAPTER HARNESS (2883232), SOLD SEPARATELY
RANGER MODELS WITHOUT RIDE COMMAND USE
MAX BOOST 10" 250 WATT SUBWOOFER (2882890), SOLD SEPARATELY
NOT COMPATIBLE WITH UNDER SEAT DRY STORAGE
(2882910) INSTALLED

AUDIO DASH SPEAKERS INCLUDE BUILT-IN FOUR CHANNEL AMPLIFIER (40-WATTS) AND TWO OFF-ROAD GRADE 13.3 CM SPEAKERS

*Due to ongoing supply chain issues, there may be delayed or limited availability of this product as an accessory add-on.

ROOFS

WINDSHIELDS
& REAR PANELS

DOORS

CAB COMFORT
& CONVENIENCE

WINCHES

PROTECTION

AUDIO

STORAGE

AUDIO

BUILD YOUR AUDIO SYSTEM

1000 / XP 1000 / XP KINETIC

ROOFS

1 CHOOSE A HEAD UNIT

Control all aspects of your sound system. Choose what to listen to and how loud.

DASH STEREO



USE AS IS OR ADD ADDITIONAL SPEAKERS



160 WATT, WATERPROOF AM/FM BLUETOOTH AUDIO SYSTEM TOP SELLER

- All-in-one solution for giving your vehicle a performance-ready sound system
- USB input, Bluetooth 4.0 compatible, Apple Control, AM/FM tuner
- Built-in four channel amplifier (40-watts x 4)
- Two off-road grade 13.3 cm speakers with titanium dome tweeters and polypropylene cones

» 2882750

XP 1000 '18-24, CREW XP 1000 '19-24, CREW 1000 '20-24, 1000 '20-24, XP KINETIC '23-24

WINDSHIELDS & REAR PANELS

DOORS

CAB COMFORT & CONVENIENCE

WINCHES

VISOR STEREO



COMES WITH OVERHEAD VISOR SPEAKERS (AT RIGHT)
USE AS IS OR ADD ADDITIONAL SPEAKERS



300 WATT AM/FM, BLUETOOTH AUDIO VISOR WITH FOUR 16.5 CM WATERPROOF SPEAKERS TOP SELLER

- One-step solution for off-road audio
- USB input, Bluetooth 4.0 compatible, Apple Control, AM/FM tuner
- 300-Watt four channel amplifier (75 watts x 4)
- Four 16.5 cm coaxial speakers with titanium dome tweeters and polypropylene cones
- Audio outputs to drive additional speakers
- Four Accessory knocks outs

» 2882888

XP 1000 '18-24, CREW XP 1000 '19-24, CREW 1000 '20-24, 1000 '20-24, XP KINETIC '23-24
NOT COMPATIBLE WITH 7" DISPLAY POWERED BY RIDE COMMAND

PROTECTION

AUDIO

STORAGE

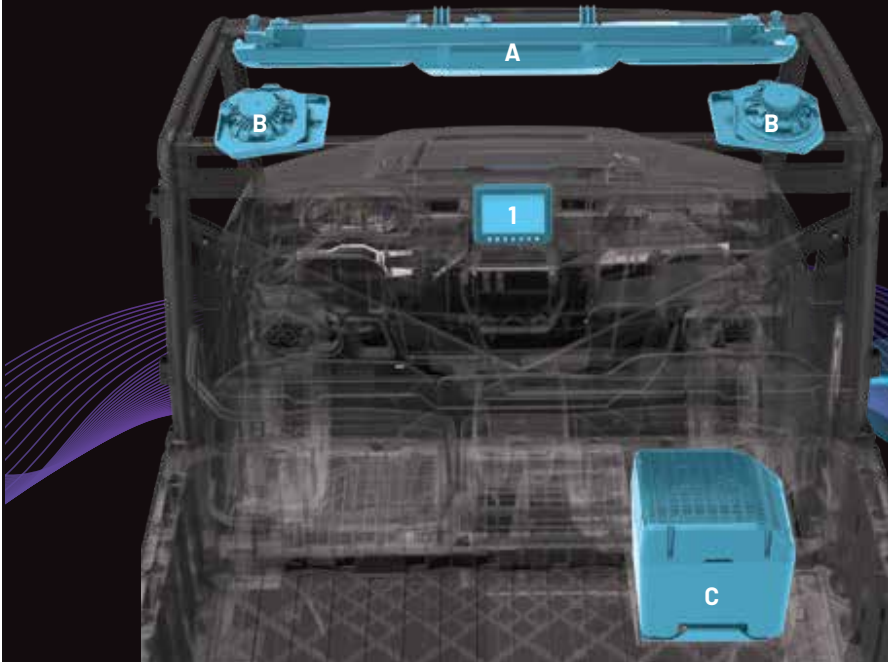

2 ADD SPEAKERS - MIX AND MATCH

Your RANGER is ready for work, but is it ready to entertain? From a simple two-speaker setup to a complete system - add speakers to BUILD IT YOUR WAY.

A VISOR SPEAKERS



STANDARD WITH VISOR STEREO

300 WATT OVERHEAD AUDIO VISOR SPEAKERS

- Built-in 300-Watt amplifier (75-watt x 4 channels)
- Four 16.5 cm speakers located in the overhead
- Waterproof system for reliable power and sound quality

» 2882891

XP 1000 '18-24, CREW XP 1000 '19-24, CREW 1000 '20-24, 1000 '20-24, XP KINETIC '23-24

B OVERHEAD SPEAKERS



REAR OVERHEAD SPEAKERS TOP SELLER

- Two 16.5 cm rear roof mounted speakers with titanium dome tweeters and polypropylene cones
- Easy install
- Waterproof system for reliable power and sound quality

» 2882876

XP 1000 '18-24, CREW XP 1000 '19-24, CREW 1000 '20-24, 1000 '20-24, XP KINETIC '23-24

C SUBWOOFER



MAX BOOST 25.4 CM 250 WATT SUBWOOFER XP 1000 ONLY

- Built-in 250-watt amplifier powering 25.4 cm waterproof subwoofer
- Fits RANGER XP 1000 with flip-up passenger seat

» 2882890

XP 1000 '18-24, CREW XP 1000 '19-24, XP KINETIC '23-24
NOT COMPATIBLE WITH 7" DISPLAY POWERED BY RIDE COMMAND
NOT COMPATIBLE WITH UNDER SEAT DRY STORAGE (2882910) INSTALLED

3 MAKE IT WORK

REQUIRED WITH VISOR STEREO SPEAKERS & HEAD UNIT

POLARIS PULSE ROOF 6 TOP SELLER

- Required with Visor Stereo (2882888)
- Required to add Visor Speakers (2882891)

» 2882904

XP 1000 '18-24, CREW XP 1000 '19-24, CREW 1000 '20-24, 1000 '20-24, XP KINETIC '23-24

CREW MODELS

CREW EXTENSION

- Required for all Crew models where Polaris PULSE Roof 6 (2882904) is required

» 2883231

CREW XP 1000 '19-24, CREW 1000 '20-24

ADDITIONAL OPTIONS

GEOFENCING KIT 1000 ONLY

- Keep vehicle operators safe by quickly setting and controlling ride boundaries such as speed limits within and outside the geofenced area
- Ensure operators are riding at the appropriate speed for their experience and terrain by setting a max speed from your RIDE COMMAND app
- Activate passcode protection and to have full control of who and when the vehicle is being operated
- Patented technology

» 2884779

CREW 1000 '20-24, 1000 '20-24

STORAGE



BUILD YOUR AUDIO SYSTEM

From opposite sides of the globe, some of the most capable machines in the off-road world meet a trusted outdoor adventure brand to deliver industry-exclusive, purpose-built roof racks, bed racks and attachments that help RANGER riders get the job done.



1000 / XP 1000 / XP KINETIC

ROOFS

WINDSHIELDS
& REAR PANELS

DOORS

CAB COMFORT
& CONVENIENCE

WINCHES

PROTECTION

AUDIO

STORAGE

PICK YOUR RACK

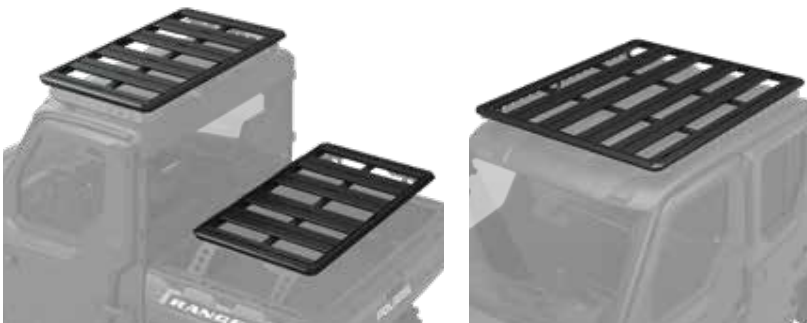

REAR BED RACK / ROOF RACK, SMALL

- Install either in the bed or on the roof of the vehicle (mounts sold separately)
- A durable backbone ensures a secure vehicle attachment
- An innovative attachment system allows for easy accessory install
- 34 kg weight capacity per rack

» 2889236

XP 1000 '18-24, 1000 '20-24, XP KINETIC '23-24

ROOF RACK, LARGE

- Install on the roof of the vehicle (mount sold separately)
- A durable backbone ensures a secure vehicle attachment
- An innovative attachment system allows for easy accessory install
- 68kg weight capacity

» 2889237

CREW XP 1000 '19-24, CREW 1000 '20-24

PICK YOUR MOUNT



REAR BED RACK MOUNT

» 2889235

XP 1000 '18-24, 1000 '20-24, CREW XP 1000 '19-24, CREW 1000 '20-24, XP KINETIC '23-24



ROOF RACK MOUNT

» 3-SEAT • 2889233

XP 1000 '18-24, 1000 '20-24, XP KINETIC '23-24

» CREW • 2889234

CREW XP 1000 '19-24, CREW 1000 '20-24



MAXIMIZE YOUR RIDE

For decades, Rhino-Rack has built some of the world's highest quality racks, accessories and mounts for the widest variety of uses and conditions. So whether you use your machine for hard work, hunting, fishing, and more, you can bring it all – and bring it on!



BUILD THE ULTIMATE UTILITY VEHICLE

Transform your vehicle for work, play or anything in between with durable and easy-to-use roof and bed racks, load securing accessories and the latest in carrier technology.



BUILT FOR THE LONG HAUL

Rhino-Rack designs and builds award-winning racks, accessories and mounts to endure the most extreme uses and conditions.

ROOFS

ACCESSORIZE IT

WINDSHIELDS & REAR PANELS



GUN MOUNTING BRACKET

- Mount Kolpin Stronghold Gun Boots to Rhino-Rack systems when paired with Auto-Latch Mount (2636942), sold separately

» 2889327

XP 1000 '18-24, CREW XP 1000 '19-24, CREW 1000 '20-24, 1000 '20-24, XP KINETIC '23-24



EYELET TIE-DOWNS

- Attach in multiple locations on the platform for additional tie-down points
- Anti-corrosive, galvanized steel for heavy duty strength
- Includes one set with hardware (straps not included)

» 2889527

XP 1000 '18-24, CREW XP 1000 '19-24, CREW 1000 '20-24, 1000 '20-24, XP KINETIC '23-24

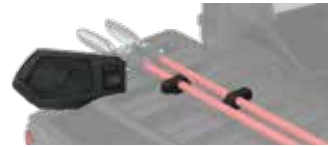

MULTI-PURPOSE TOOL HOLDER

- Carry and protect tools, paddles and more
- Ratchet-locking mechanism for quick release and rubber inserts that secure gear into place

» 2889528

XP 1000 '18-24, CREW XP 1000 '19-24, CREW 1000 '20-24, 1000 '20-24, XP KINETIC '23-24



SPARE TYRE HOLDER

- Transport a spare tyre outside the vehicle
- Easily mounts to the Rhino-Rack Rear Bed Rack (2889590), sold separately

» 2889529

XP 1000 '18-24, CREW XP 1000 '19-24, CREW 1000 '20-24, 1000 '20-24, XP KINETIC '23-24

DOORS

CAB COMFORT & CONVENIENCE



TRACTION BOARD MOUNTS

- Strong, durable and easy to attach
- Traction boards sold separately

» 2889530

XP 1000 '18-24, CREW XP 1000 '19-24, CREW 1000 '20-24, 1000 '20-24, XP KINETIC '23-24



CARGO CORNER BRACKETS

- Mount a NorthStar cooler or toolbox to the platform and save space inside the vehicle (straps not included)
- A unique, anti-rotation nut offers maximum security

» 2889531

XP 1000 '18-24, CREW XP 1000 '19-24, CREW 1000 '20-24, 1000 '20-24, XP KINETIC '23-24



HIGH-LIFTING JACK MOUNT

- Simple, quick install with durable brackets
- Rugged, non-corrosive powder-coated steel stands up to the harshest conditions

» 2889533

XP 1000 '18-24, CREW XP 1000 '19-24, CREW 1000 '20-24, 1000 '20-24, XP KINETIC '23-24



200 L LUGGAGE BAG

- Carry bulky, lightweight gear in this tear- and weather-resistant canvas bag

» 2889881

XP 1000 '18-24, CREW XP 1000 '19-24, CREW 1000 '20-24, 1000 '20-24, XP KINETIC '23-24

WINCHES

PROTECTION

AUDIO



FISHING ROD HOLDER

- Convenient, locking carrier can transport five fishing rods safely and securely on a roof rack
- Doubles as a ski/snowboard carrier

» 2889729

XP 1000 '18-24, CREW XP 1000 '19-24, CREW 1000 '20-24, 1000 '20-24, XP KINETIC '23-24



J-STYLE KAYAK HOLDER

- Transport a kayak or canoe on the roof of your vehicle

» 2889883

XP 1000 '18-24, CREW XP 1000 '19-24, CREW 1000 '20-24, 1000 '20-24, XP KINETIC '23-24
REQUIRES ACCESSORY BARS (2889884), SOLD SEPARATELY

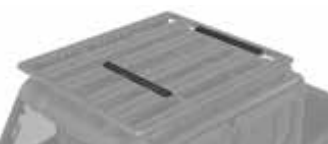

ACCESSORY BARS

- Offers horizontal fitment to allow other accessories to be attached to the Rhino-Rack® platforms

» 2889884

XP 1000 '18-24, CREW XP 1000 '19-24, CREW 1000 '20-24, 1000 '20-24, XP KINETIC '23-24

STORAGE

STORAGE



Exclusive to Polaris, Lock & Ride accessories let you quickly change from one task to another with hundreds of options.

With the flip of a lever, Lock & Ride plungers use outward pressure to expand for secure fit.



1000 / XP 1000 / XP KINETIC



NEW 300 LB. REAR CARGO BOX WINCH

- 300 lb. pull force winch that mounts to rear headache rack
- Allows for easy loading of big game or other large and heavy items in the bed

» 2889705

XP 1000 '18-24, CREW XP 1000 '19-24, CREW 1000 '20-24, 1000 '20-24, XP KINETIC '23-24

REQUIRES LOCK & RIDE HEADACHE RACK (2890233), SOLD SEPARATELY



FRONT BRUSHGUARD STORAGE RACK

- Allows extra storage space in front of your vehicle
- Accommodates a Polaris Northstar 28 L Cooler or similar sized items
- Attaches and removes easily
- Mounts to existing plow mounting points

» 2883971

XP 1000 '18-24, CREW XP 1000 '19-24, CREW 1000 '20-24, 1000 '20-24, XP KINETIC '23-24

NOT COMPATIBLE WITH BIG GAME OR WATERFOWL MODELS (NO FACTORY PLOW MOUNTS)

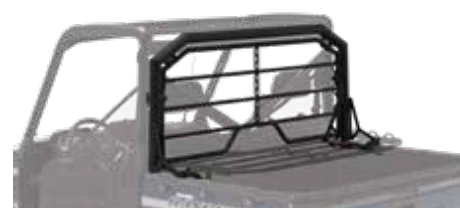

HEADACHE RACK TOP SELLER

- Lightweight and heavy-duty rack protects the cab of your RANGER and lets you haul even more

» 2890233

XP 1000 '17-24, CREW XP 1000 '18-24, CREW 1000 '20-24, 1000 '20-24, XP KINETIC '23-24



CARGOMAX SYSTEM

- Comes standard with a support bar that ties the two sides together for a sturdy cargo hold
- Designed to attach to the Lock & Ride Tip-Down Headache Rack for additional support and three-sided containment
- Adjustable utility hooks provide more options for hanging tools, cords or gear

» 2882177

XP 1000 '17-24, CREW XP 1000 '18-24, CREW 1000 '20-24, 1000 '20-24, XP KINETIC '23-24



FRONT HOOD STORAGE RACK

- Front curve helps keep cargo in place when traveling
- Provides additional protection
- Fully integrated pivots to gain under-hood access
- Requires Bumper Adapter 2207941 when used with 7" Display powered by RIDE COMMAND

» 2882690

XP 1000 '18-24, CREW XP 1000 '19-24, CREW 1000 '20-24, 1000 '20-24, XP KINETIC '23-24

DOES NOT FIT WITH BUMPER 2882531

REQUIRES BUMPER ADAPTER (2207941), SOLD SEPARATELY, TO WORK WITH FRONT CAMERA



REAR SEAT STORAGE - CREW

- Attaches easily to the rear of the front seat in your crew vehicle
- Provides storage pockets for a variety of items, ensuring they're always within reach

» 2889268

CREW XP 1000 '18-24, CREW '20-24



BED EXTENDER/DIVIDER

- Extend or divide the cargo box
- Installs in any location in the box
- Multiple tie-down points available to secure cargo



» 2882752

XP 1000 '18-24, CREW XP 1000 '19-24, CREW 1000 '20-24, 1000 '20-24, XP KINETIC '23-24

ROOFS

WINDSHIELDS & REAR PANELS

DOORS

CAB COMFORT & CONVENIENCE

WINCHES

PROTECTION

AUDIO

STORAGE

75+ COMBINATIONS TO MAKE IT YOUR OWN

With a full line of Lock & Ride accessories, you can haul more and do more. Use the chart below to see what combinations work together.

POLARIS RANGER STORAGE MATRIX 1000 / XP 1000 / XP KINETIC 570 FULL-SIZE	Headache Rack	CargoMax System	Bed Extender/Divider	Storage Box	Tool Rack	Chainsaw Mount	60 Gallon Boomless Utility Sprayer	300 Lb. Rear Cargo Box Winch	Front Brushguard Storage Rack	Cargo Bed Mat	RHINO-RACK Roof Rack - 3-Seat	RHINO-RACK Bed Rack - 3-Seat & Crew	RHINO-RACK Roof Rack - Crew
	2890233	2882177	2882752	2883279	2881533	2879354	2879799	2889705	2883971	2882751	2889236	2889236	2889237
Headache Rack 2890233	✓	✓	✓	✓		✓	✓	✓	✓	✓	✓		✓
CargoMax System 2882177	✓	✓		✓ ²					✓	✓	✓		✓
Bed Extender/Divider 2882752	✓		✓	✓	✓	✓		✓	✓	✓	✓		✓
Storage Box 2883279	✓	✓ ¹	✓	✓	✓	✓		✓	✓	✓	✓		✓
Tool Rack 2881533			✓	✓	✓	✓		✓	✓	✓	✓		✓
Chainsaw Mount 2879354	✓		✓	✓	✓	✓		✓	✓	✓	✓		✓
60 Gallon Boomless Utility Sprayer 2879799	✓						✓	✓	✓	✓	✓		✓
NEW 300 Lb. Rear Cargo Box Winch 2889705	✓		✓	✓	✓	✓	✓	✓	✓	✓	✓		✓
Front Brushguard Storage Rack 2883971	✓	✓	✓	✓	✓	✓	✓	✓	✓	✓	✓	✓	✓
Cargo Bed Mat 2882751	✓	✓	✓	✓	✓	✓	✓	✓	✓	✓	✓	✓	✓
RHINO-RACK Roof Rack - 3-Seat 2889236	✓	✓	✓	✓	✓	✓	✓	✓	✓	✓	✓	✓	✓
RHINO-RACK Bed Rack - 3-Seat & Crew 2889236									✓	✓	✓	✓	✓
RHINO-RACK Roof Rack - Crew 2889237	✓	✓	✓	✓	✓	✓	✓	✓	✓	✓	✓	✓	✓

¹ Storage box at front of cargo box if not used with Tip-down Headache Rack

² Storage box at front of cargo box

QUICKSTRAP

- The quickest and most secure way to mount Polaris accessories
- Sold as a pair
- » 2882187
- ALL COOLERS, RANGER CARGO BOXES



D-RINGS TOP SELLER

- The most versatile Lock & Ride accessory - add as many as you need to secure your cargo with bungee cords or straps
- » 2881545
- ALL RANGER CARGO BOXES



3.8 CM X 4.6 M 2495 KG RATCHET STRAP

- Heavy-duty webbing
- 2,495 kg maximum load / 831 kg working load
- 2 Pack
- » 2884031

5.1 CM X 6.1 M 4536 KG RATCHET STRAP

- Heavy-duty webbing
- 4,536 kg maximum load / 1,497 kg working load
- Floating D-Rings and Double J-Hooks
- » 2884032

STORAGE



NEW
TRASH CAN HAULER

- Receiver mounted trash can hauler that allows slow speed towing of 2 trash cans
- Ideal for hauling cans down long driveways

» 2889876

XP 1000 '18-24, CREW XP 1000 '19-24, CREW 1000 '20-24, 1000 '20-24, XP KINETIC '23-24



NEW
SPARE TYRE MOUNT

- Includes one spare tyre carrier
- Quick installation
- Tyre carrier mounts to the rear cab to keep cargo bed free and easily accessible
- Maximum tyre size supported is 30"

» 2889193

XP 1000 '18-24, CREW XP 1000 '19-24, CREW 1000 '20-24, 1000 '20-24, XP KINETIC '23-24



LOCK & RIDE
CHAINSAW MOUNT

- Can be secured to the outside of the bed wall so your chainsaw is within reach at all times

» 2879354

XP 1000 '17-24, CREW XP 1000 '18-24, CREW 1000 '20-24, 1000 '20-24, XP KINETIC '23-24



LOCK & RIDE
227 L BOOMLESS UTILITY SPRAYER

» 2879799

XP 1000 '17-24, CREW XP 1000 '18-24, CREW 1000 '20-24, 1000 '20-24, XP KINETIC '23-24

1000 / XP 1000 / XP KINETIC

ROOTS

WINDSHIELDS & REAR PANELS

DOORS

CAB COMFORT & CONVENIENCE

WINCHES

PROTECTION

AUDIO

STORAGE

BED ESSENTIALS



RIDE & REPAIR ESSENTIALS KIT

» 2881207

XP 1000 '17-24, CREW XP 1000 '18-24, CREW 1000 '20-24, 1000 '20-24, XP KINETIC '23-24



FIRE EXTINGUISHER HOLDER

- Only holds a 8.3 cm diameter extinguisher
- Quick release strap allows for easy use

» 2882158

XP 1000 '17-24, CREW XP 1000 '18-24, CREW 1000 '20-24, 1000 '20-24, XP KINETIC '23-24



CARGO BED MAT

- Non-slip surface to better secure loads and keep cargo bed clean

» 2882751

XP 1000 '18-24, CREW XP 1000 '19-24, CREW 1000 '20-24, 1000 '20-24, XP KINETIC '23-24



ELECTRONIC CARGO BOX LIFT

» 2884141

XP 1000 '18-24, CREW XP 1000 '19-24, CREW 1000 '20-24, 1000 '20-24, XP KINETIC '23-24



TASK-SPECIFIC TOOLS

LR LOCK RIDE TOOL RACK

- Attach on the inside or outside of the cargo bed
- » 2881533
- XP 1000 '17-24, CREW XP 1000 '18-24, CREW 1000 '20-24, 1000 '20-24, XP KINETIC '23-24



ORGANIZE & PROTECT

LR LOCK RIDE STORAGE BOX

- Enough room to store all the tools you need to get the job done
- Internal organizational dividers keep gear from rolling around
- Easily detaches from vehicle
- » 2883279
- XP 1000 '17-24, CREW XP 1000 '18-24, CREW 1000 '20-24, 1000 '20-24, XP KINETIC '23-24



DO MORE:



COOLERS P. 84



HUNT P. 86



COLD WEATHER P. 90



LIGHTING P. 94

ROOFS



POLY FEATURES

- Water run-off
- Polaris PULSE plug and play
- Liner ready
- Lightweight



SEALED COVERAGE



REDUCE STANDING WATER



EASY AND FAST INSTALLATION

POLARIS ENGINEERED ADVANTAGES

POLY

Lightweight, durable and impact-resistant. A poly roof can take the abuse of a tight trail and still protect.



2-SEAT



CREW



SPORT ROOF - POLY

- Offers reliable protection from the sun and rain
- Lightweight, durable polyethylene construction
- Simple one-time installation

- » 2-SEAT • BLACK • 2885077
SP 570 '22-24
- » CREW • BLACK • 2885078
CREW SP 5770 '22-24

PREMIUM ROOF LINER

- Cut in-cab noise by 60% at idle and by 40% at 20 mph
- One-piece liner attaches quickly and securely using push darts
- Adds premium comfort and quieter cab ride
- » 2-SEAT (SHOWN) • 2885093
SP 570 '22-24
- » CREW • 2885094
CREW SP 570 '22-24

DOORS

POLARIS ENGINEERED ADVANTAGES



PREMIUM FEATURES



UNPRECEDENTED VENTILATION OPTIONS



EASY AND FAST INSTALLATION

RANGER SP 570

ROOFS & DOORS

WINDSHIELDS & REAR PANELS

AUDIO, CAB COMFORT & CONVENIENCE

PROTECTION & WINCHES

STORAGE

POLY

CRANK WINDOW

Has manual crank windows for airflow adjustment in the cab with a fully finished black interior and exterior panels. Has a steel tube frame with a full 360° seal to keep out dust and rain.



MANUAL CRANK WINDOW DOORS

» FRONT • 2885073

SP 570 '22-24, CREW SP 570 '22-24
SHOWN WITH EXTERIOR DOOR
ACCENT PANEL 2889389-795

» REAR • 2885074

CREW SP 570 '22-24
SHOWN WITH EXTERIOR DOOR
ACCENT PANEL 2889390-795

CANVAS

ZIP WINDOW

Heavy-duty 23-oz durable protection with adjustable zipper ventilation and see-through bottom panel. Powder-coated steel rod door frames provide strength and enhance fit and finish.



MANUAL CRANK WINDOW DOORS

» FRONT • 2885075

SP 570 '22-24, CREW SP 570 '22-24

» REAR • 2885076

CREW SP 570 '22-24



EXTERIOR DOOR ACCENT PANELS

- Replace stock gloss black accent panels
- Painted plastic and clear-coated for UV protection
- Install easily with a single screw
- Comes as a pair
- Compatible with Poly doors only

 GHOST GRAY
FRONT 2889389-728
REAR 2889390-728

 POLARIS PURSUIT CAMO
2889391-587
2889392-587

 SAGEBRUSH GREEN NON-METALLIC
2889389-560
2889390-560

 POLARIS BLUE NON-METALLIC
2889389-795
2889390-795

WINDSHIELDS & REAR PANELS

GLASS vs HARD COAT POLY

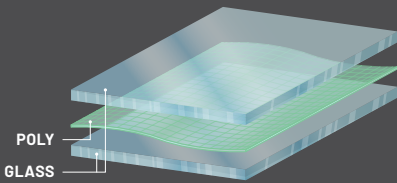

Superior optical clarity (automotive level)
 Scratch-resistant
 Curved to fit, seals tight
 Cold weather / heavy duty
 Wiper ready

Lightweight, flexible, easy to store/remove
 Impact-resistant
 Tight seal keeps out rain and dust
 30x more scratch resistant

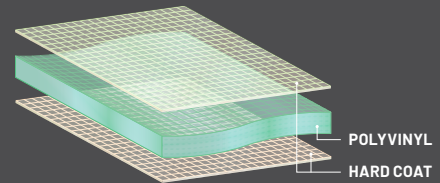

WINDSHIELDS

OPEN



PRO SHIELD CAB SYSTEM

FULL TIP-OUT WINDSHIELD - GLASS

- Tip-out design offers three positions: open, closed and vented
- Gas shocks assist in easy opening and closing
- 360° gasket for reliable protection and comfort
- Scratch-resistant automotive-style curved glass
- Interior sound dampening and optimized visibility

» 2885079

SP 570 '22-24, CREW SP 570 '22-24



LR LOCK & RIDE

VENTED WINDSHIELD - HARD COAT POLY

- Frameless design for maximum visibility
- Added vents for airflow on a hot day or defrosting on a cold day

» 2883342

SP 570 '22-24, CREW SP 570 '22-24



LR LOCK & RIDE

FULL WINDSHIELD - POLY TOP SELLER

- Durable, optical-grade, 0.6 cm-thick polycarbonate offers outstanding rider protection and visibility
- Windshield has minimal perimeter framework for full visibility

» 2883318

SP 570 '22-24, CREW SP 570 '22-24



WIPER AVAILABLE
 P. 70

PRO SHIELD CAB SYSTEM

FULL GLASS WINDSHIELD - CLEAR

- Scratch-resistant, curved laminate safety glass
- Protects against wind, rain and other hazardous debris
- UV-blocking interlayer and 360° gasket seal

» 2885080

SP 570 '22-24, CREW SP 570 '22-24



LR LOCK & RIDE

FULL WINDSHIELD - HARD COAT POLY TOP SELLER

- Durable, optical-grade, 0.6 cm-thick polycarbonate offers outstanding rider protection and visibility
- Windshield has minimal perimeter framework for full visibility

» 2883319

SP 570 '22-24, CREW SP 570 '22-24



LR LOCK & RIDE

HALF WINDSHIELD - POLY

- Strong, durable polycarbonate half windshield delivers a combination of protection and airflow into the cab
- Half windshield offers protection from rain, sleet, spray, and off-road hazards

» 2883320

SP 570 '22-24, CREW SP 570 '22-24



POLARIS ENGINEERED ADVANTAGES



REVOLUTIONARY INSTALLATION

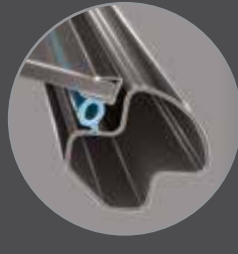

AIRTIGHT GASKET SEAL



VENTING OPTIONS



MULTI-FUNCTION FEATURES



REAR PANELS



PRO SHIELD CAB SYSTEM

LOCK & RIDE REAR PANEL - GLASS TOP SELLER

- Durable, tempered laminate glass provides a high level of scratch resistance
- » 2879965

SP 570 '22-24, CREW SP 570 '22-24



LOCK & RIDE REAR PANEL - POLY TOP SELLER

- Strong, 0.6 cm-thick polycarbonate provides outstanding impact and scratch resistance
- » 2879812

SP 570 '22-24, CREW SP 570 '22-24

PROTECTION & WINCHES

STORAGE



REDUCE IN-CAB DUST SWIRL BY ADDING A REAR PANEL

With a windshield and roof installed, turbulent air develops behind the cab. Add a rear panel to reduce dust intrusion from this swirl.

AUDIO

POLARIS RIDE COMMAND

7" DISPLAY POWERED BY RIDE COMMAND*

» 2884072

SP 570 '22-24
SPEAKERS NOT INCLUDED



MORE INFORMATION P. 78



JBL DASH AUDIO KIT

- System mounts into pre-designated locations in the vehicle dash
- Complete UTV audio solution gives your vehicle a performance-ready sound system
- Includes four off-road grade, water- and dust-proof speakers, and one head unit
- Head unit features AM/FM tuner, USB input and Bluetooth compatibility for wireless streaming

» 2885081

SP 570 '22-24

CAB COMFORT & CONVENIENCE



HEATER KIT

- Climate control for the cab of your off-road vehicle
- Total of four dash mounted vents with two positioned for defrosting the windshield and the other two for heating the cab
- Simple, dash-mounted controls
- Manually operated vents for airflow control

» 2885082

SP 570 '22-24, CREW SP 570 '22-24

SP 570 SPORT MODELS REQUIRES FRONT PULSE BAR AND HARNESSSES (2889185), SOLD SEPARATELY



CONVEX WEATHERPROOF REAR VIEW MIRROR

- Convex design for a broader view of traffic
- Durable, weatherproof construction
- Mount the bolts into your choice of pre-designated mounting locations
- Compatible with roof, windshield, and other accessories

» 2889187

SP 570 '22-24, CREW SP 570 '22-24



SIDE VIEW MIRRORS

» DOOR MOUNTED • 2889241

» ROPS-MOUNTED (SHOWN) • 2889243

SP 570 '22-24, CREW SP 570 '22-24



WINDSHIELD WIPER & WASHER KIT

- Helps clear hazardous dirt, rain and debris from your windshield

» 2885083

SP 570 '22-24, CREW SP 570 '22-24

SP 570 SPORT MODELS REQUIRES FRONT PULSE BAR AND HARNESSSES (2889185), SOLD SEPARATELY



SUN VISOR

- Injection molded visor that flips down to reduce sun glare in early morning or at dusk
- Can be mounted on passenger or drivers side

» 2890571

SP 570 '22-24, CREW SP 570 '22-24



FLOOR MATS - FRONT

- Protects floors from dirt and wear
- Textured, non-slip surface

» 2889186

SP 570 '22-24, CREW SP 570 '22-24

CAB SEAL KIT

- Seal out dust from your UTV cab
- Reduces dust from getting on dash and seat

» 2889201

SP 570 '22-24, CREW SP 570 '22-24

(INCLUDED WITH PREMIUM DOORS)

DOMELIGHT

- LED Dome light provides optimal visibility in the
- Easy to install

» 2889159

SP 570 '22-24, CREW SP 570 '22-24

SP 570 NON-PREMIUM AND NON-NORTHSTAR MODELS REQUIRE FRONT PULSE BAR AND HARNESSSES 2889185

HORN KIT

- Adds a warning horn to console area of vehicle

» 2889160

SP 570 '22-24, CREW SP 570 '22-24

SP 570 NON-PREMIUM AND NON-NORTHSTAR MODELS REQUIRE FRONT PULSE BAR AND HARNESSSES 2889185

FRONT PULSE BAR AND HARNESS

- This kit is needed to install any electrical accessories to a base vehicle

» 2-SEAT • 2889185

SP 570 '22-24, CREW SP 570 '22-24

» CREW • 2889568

CREW SP 570 '22-24

ELECTRONIC POWER STEERING KIT**

- Smoothest, most powerful electronic power steering available for your Polaris RANGER
- Variable assist for easier steering at lower speeds
- Greater responsiveness at higher speeds
- Front PULSE Bar and Harness required, sold separately

» 2889464

» EPS HARNESS KIT • 2890069

SP 570 '22-24, CREW SP 570 '22-24

SPEEDKEY

» 2879988

SP 570 '22-24, CREW SP 570 '22-24

*Due to ongoing supply chain issues, there may be delayed or limited availability of this product as an accessory add-on.
**Check with your local dealer for availability.

PROTECTION

RANGER SP 570



UPPER FRONT BRUSHGUARD

- Made from tubular steel and provides additional protection for front fenders and headlights
- Attaches to stock front bumper
- Durable, scratch-resistant, black powder-coat finish

» 2885084

SP 570 '22-24, CREW SP 570 '22-24
 FITS PREMIUM MODELS ONLY
 NOT COMPATIBLE WITH HOOD RACK (2885088)
 USES SAME MOUNTING LOCATIONS
 REQUIRES PREMIUM WELD-BUMPER (1026432-458), SOLD SEPARATELY



REAR BRUSHGUARD

- Made from tubular steel and provides additional protection for taillights
- Durable, scratch-resistant, black powder-coat finish
- Reliably enhances back-end protection of vehicle

» 2885087

SP 570 '22-24, CREW SP 570 '22-24



ROCK GUARD WITH STEP

- Reliable, hard-working protection for edges of vehicle
- Mounts directly to the frame, instead of underneath, for maximum ground clearance

» 2-SEAT (SHOWN) • 2889180

SP 570 '22-24
 » CREW • 2889181
 CREW SP 570 '22-24



A-ARM GUARDS

- Valuable, reliable protection for vital front suspension components exposed to the rigors of off-road environments

- Strong, durable, lightweight polyethylene construction withstands off-road impacts to protect the A-Arms

» FRONT (SHOWN) • 2885097

» REAR • 2880551
 SP 570 '22-24, CREW SP 570 '22-24
 NOT COMPATIBLE WITH MODELS THAT HAVE FRONT SWAY BAR

ROOFS & DOORS

WINDSHIELDS & REAR PANELS

AUDIO, CAB COMFORT & CONVENIENCE

PROTECTION & WINCHES

STORAGE

WINCHES



FEATURES & BENEFITS

PRO PRO HEAVY DUTY SERIES

HD HEAVY DUTY SERIES

RAPID ROPE RECOVERY

Retrieve cable 5x as fast as standard mode on other Polaris winches. Get back to riding or complete your task quicker.



NOT AVAILABLE

AUTO STOP TECHNOLOGY

Auto Stop technology protects and extends the life of your winch by automatically stopping the winch at the end of pull to prevent over-spooling.



AUTO STOP UPGRADE
 + WIRELESS REMOTE
 2889840

WIRELESS REMOTE

Operate your winch wirelessly from within 50 ft of the vehicle.

WIRELESS STANDARD, WIRED OPTION

SYNTHETIC ROPE REQUIRED

PREMIUM SYNTHETIC ROPE

Lightweight, extremely strong and flexible 50 ft long rope stands up to any tough job.



ADD SYNTHETIC ROPE
 2878888

MODEL

2,041 KG

1,588 KG

ADD REQUIRED CABLES

SP 570 '22-24
 CREW SP 570 '22-24

2885096

TOP SELLER
 2885095

2-SEAT
 & CREW MODELS
 2889185

UPGRADE YOUR CONTROLS HD OR PRO HD WINCHES

WIRED REMOTE CONTROL

- Must order remote handle and socket together

» REMOTE HANDLE
 4013466

» SOCKET
 4014228

POWER CONTROLLER

- Control your winch and plow hydraulics directly from the shift knob

» 2889162
 SP 570 '22-24



STORAGE



Exclusive and available on all Polaris vehicles, Lock & Ride accessories let you quickly change from one task to another with hundreds of options.

With the flip of a lever, Lock & Ride plungers use outward pressure to expand for a secure fit.



LR SPARE TYRE MOUNT

- Includes one spare tyre carrier
- Quick installation
- Tyre carrier mounts to the rear cab to keep cargo bed free and easily accessible
- Maximum tyre size supported is 30"

» 2889193
SP 570 '22-24, CREW SP 570 '22-24



LR STORAGE BOX

- Provides enough room to store all the tools you need to get the job done
- Internal organizational dividers keep gear from rolling around
- Easily detaches from vehicle

» 2889199
SP 570 '22-24, CREW SP 570 '22-24



HEADACHE RACK

- Provides extreme cargo versatility to your UTV
- Strong steel tube construction for maximum durability

» 2889538
SP 570 '22-24, CREW SP 570 '22-24



LR BED EXTENDER/DIVIDER

- Increase your cargo capacity and UTV storage
- Extend the cargo bed or divide cargo within the bed
- Lock & Ride technology for easy install without tools
- Made from durable steel and powder-coated finish

» 2889183
SP 570 '22-24, CREW SP 570 '22-24



CARGO BED MAT

- Protects cargo box, reduces drivetrain noise, and keeps cargo more secure with non-slip design
- Thick (3.18 mm) rubber mat construction

» 2889189
SP 570 '22-24, CREW SP 570 '22-24



LR LOCK & RIDE TOOL RACK

- Attach on the inside or outside of the cargo bed
- » 2881533
- SP 570 '22-24, CREW SP 570 '22-24



LR LOCK & RIDE FRONT HOOD STORAGE RACK

- Increases load-carrying capacity and protects against brush and debris
- Steel construction with a durable powder-coated finish
- Lock & Ride functions for easy install, on and off maneuvering of the basket, and under-hood access
- Weight Capacity: 100 lbs.
- » 2885088
- SP 570 '22-24, CREW SP 570 '22-24
- NOT COMPATIBLE WITH UPPER BRUSH GUARD (2885084) AS IT USES SAME MOUNTING POINTS



NEW TRASH CAN HAULER

- Receiver mounted trash can hauler that allows slow speed towing of 2 trash cans
- Ideal for hauling cans down long driveways
- » 2889876
- SP 570 '22-24, CREW SP 570 '22-24



NEW 300 LB. REAR CARGO BOX WINCH

- 300 lb. pull force winch that mounts to rear headache rack
- Allows for easy loading of big game or other large and heavy items in the bed
- » 2890137
- SP 570 '22-24, CREW SP 570 '22-24
- REQUIRES HEADACHE RACK (2889538), SOLD SEPARATELY



RIDE & REPAIR ESSENTIALS KIT

- » 2881207
- SP 570 '22-24, CREW SP 570 '22-24



LR LOCK & RIDE CHAINSAW MOUNT

- » 2879354
- SP 570 '22-24, CREW SP 570 '22-24



LR LOCK & RIDE D-RINGS TOP SELLER

- The most versatile Lock & Ride accessory: add as many as you need to secure your cargo with bungee cords or straps
- » 2881545
- SP 570 '22-24, CREW SP 570 '22-24



FIRE EXTINGUISHER HOLDER

- Quick-release strap allows for easy access
- » 2882158
- SP 570 '22-24, CREW SP 570 '22-24

STRAPS

3.8 CM X 4.6 M 2494.8 KG RATCHET STRAP

- Heavy-duty webbing
- 2 pack
- » 2884031



LR LOCK & RIDE QUICKSTRAP

- The quickest and most secure way to mount Polaris accessories
- Sold as a pair
- » 2882187
- ALL COOLERS, RANGER CARGO BOXES



5.1 CM X 6.1 M 4535.9 KG RATCHET STRAP

- Heavy-duty webbing
- » 2884032



DO MORE:



COOLERS P. 84



HUNT P. 86



COLD WEATHER P. 90



LIGHTING P. 94

RANGER 150 EFI



YOUTH CRAWLER TYRE

- Premium durability to ride longer
 - Increased ground clearance and performance
- 150 EFI '18-24



YOUTH BUCKLE WHEEL

- » FRONT • 12" x 7" • 1524114
 - » REAR • 12" x 8" • 1524115
- 150 EFI '18-24



PRO ARMOR WHEEL & TYRE KIT: YOUTH CRAWLER & BUCKLE

- » 2885154
- 150 EFI '18-24

		TREAD DEPTH	TYRE WEIGHT	PLY RATING	SIDEWALL BELTS	LOAD RATING
12"	22" x 8" R12 5416945	13 mm	13 kg	6	3	413 kg
12"	22" x 10" R12 5416944					
	FRONT/ REAR					



FULL WINDSHIELD - POLY

- .32 cm clear poly carbonate
- Mounts with Lock & Ride

» 2889854
150 EFI '18-24



HALF WINDSHIELD - POLY

- 33 cm tall to provide protection and allow airflow
- .32 cm clear poly carbonate
- Mounts with Lock & Ride

» 2889855
150 EFI '18-24



REAR PANEL - POLY

- .32 cm clear poly carbonate
- Mounts with Lock & Ride

» 2889856
150 EFI '18-24



FRONT & REAR BRUSHGUARD SET

- Durable, e-coated steel construction
- Front and rear brushguard included

» 2883287
150 EFI '18-24



SPORT ROOF - POLY

- Stay protected from rain, snow and sun
- Easily installs

» 2883289
150 EFI '18-24

ELECTRICAL ACCESSORIES



COMMON ACCESSORIES

CONNECTED TECHNOLOGY

ELECTRICAL ACCESSORIES

TRACKS

COOLERS

HUNT

WINCHES

LIGHTING

WHEELS & TYRES

ADD ELECTRICAL SYSTEM ACCESSORIES IN 4 EASY STEPS

Polaris PULSE is a revolutionary way to provide additional power locations on your vehicle, and makes adding electrical accessories a snap. Electrical accessories are easier to install, with designated routing areas and plug and play connections.

Look for  to identify Polaris PULSE ready accessories.

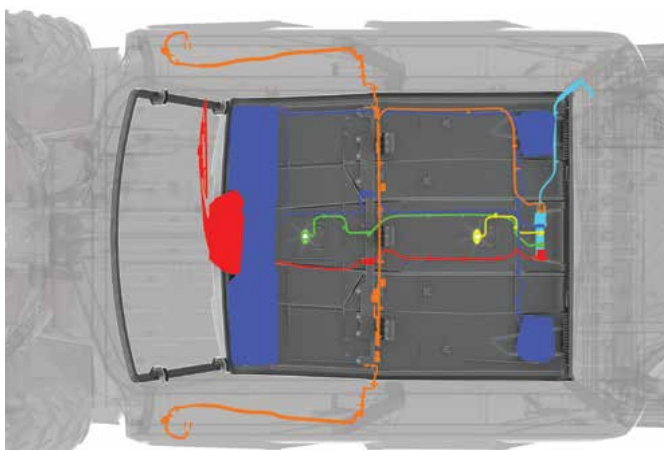

CREW XP 1000 POLARIS PULSE WIRING SHOWN



STEP 1

CHOOSE A POLARIS PULSE READY ROOF	XD 1500	CREW XD 1500	1000 XP 1000 XP KINETIC	CREW 1000 XP 1000	SP 570	CREW SP 570
Premium Roof - Poly - Polaris Pursuit Camo		N/A	2882913	N/A		N/A
Premium Roof - Poly - Black		N/A	2882912	N/A		N/A
Sport Roof - Poly - Black		N/A	2882911	2889223	2885077	2885078

STEP 2

ADD THE POLARIS PULSE ROOF 6	XD 1500	CREW XD 1500	1000 XP 1000 XP KINETIC	CREW 1000 XP 1000	SP 570	CREW SP 570
Polaris PULSE Roof 6	2890262	2890441	2882904			
Polaris PULSE Wiring Harness - Crew Extension		N/A	N/A			2889185

STEP 3 ADD ACCESSORIES*

POWER WINDOW DOORS	XD 1500	CREW XD 1500	1000 XP 1000 XP KINETIC	CREW 1000 XP 1000	SP 570	CREW SP 570
Polaris PULSE Wiring Harness - Crew Extension		N/A	N/A	2883231		N/A

WINDSHIELD WIPER & WASHER SYSTEM	XD 1500	CREW XD 1500	1000 XP 1000 XP KINETIC	CREW 1000 XP 1000	SP 570	CREW SP 570
Windshield Wiper & Washer System		2889095	2883974		2885083	
Polaris PULSE Wiring Harness - Crew Extension		N/A	N/A	2883231		2889185

WORK LIGHT	XD 1500	CREW XD 1500	1000 XP 1000 XP KINETIC	CREW 1000 XP 1000	SP 570	CREW SP 570
Rear LED Work Light		2889771	2889672			
Polaris PULSE Wiring Harness - Crew Extension		N/A	N/A	2883231		2889185

AUDIO: DASH RADIO & VISOR SPEAKERS	XD 1500	CREW XD 1500	1000 XP 1000 XP KINETIC	CREW 1000 XP 1000	SP 570	CREW SP 570
160 Watt, Waterproof AM/FM Bluetooth Audio System		N/A	2882750		N/A	
300 Watt Overhead Audio Visor Speakers		N/A	2882891		N/A	
JBL Dash Audio Kit		N/A	N/A		2885081	
Polaris PULSE Wiring Harness - Crew Extension		N/A	N/A	2883231		2889185

AUDIO: VISOR AUDIO + REAR SPEAKERS	XD 1500	CREW XD 1500	1000 XP 1000 XP KINETIC	CREW 1000 XP 1000	SP 570	CREW SP 570
300 Watt AM/FM, Bluetooth Audio Visor with Four 16.5 cm Waterproof Speakers		N/A	2882888		N/A	
Rear Overhead Speakers		N/A	2882876		N/A	
JBL Trail Pro 4200 Audio Upgrade Kit		2889763	N/A		N/A	
Polaris PULSE Wiring Harness - Crew Extension		N/A	N/A	2883231		N/A

*Add accessories to models without 7" Display Powered by RIDE COMMAND

STEP 4 ADD ACCESSORIES*

CONCEAL WIRING FOR A FINISHED, COMFORTABLE LOOK	XD 1500	CREW XD 1500	1000 XP 1000 XP KINETIC	CREW 1000 XP 1000	SP 570	CREW SP 570
Premium Roof Liner		N/A	2882914	2883457	2885093	2885094

ELECTRICAL ACCESSORIES



COMMON ACCESSORIES

CONNECTED TECHNOLOGY

ELECTRICAL ACCESSORIES

TRACKS

COOLERS

HUNT

WINCHES

LIGHTING

WHEELS & TYRES

THE FOLLOWING ACCESSORIES EASILY PLUG INTO THE FACTORY INSTALLED POLARIS PULSE UNDER THE HOOD:

	XD 1500	1000 / XP 1000 / XP KINETIC	SP 570
Heater & Defrost System	P. 24	P. 46 / 39	P. 70
Horn	P. 24	P. 48	P. 70
Plow Controller	P. 25	P. 49	P. 71
Audio System	P. 27	P. 52	P. 70
Light Bars	P. 94	P. 94	P. 94



POLARIS PULSE UNDERHOOD BUS BAR - 6 POSITION

• If upgrading to more than three accessories attaching to the underhood PULSE location, replace 3-Position Bus Bar with the Polaris PULSE Underhood Bus Bar - 6 Position

» **2884183** 1000 ONLY
CREW 1000 '20-24, 1000 '20-24

POLARIS FRONT PULSE BAR AND HARNESS

• This kit is required to install any electrical accessories on a base RANGER SP 570

» **2889185**
SP 570 '22-24

POLARIS PULSE BATTERY TENDER ADAPTER

• Connects your trickle charger to your vehicle

» **2884297**
XP 1000 '18-21, CREW XP 1000 '19-24, CREW 1000 '20-24, 1000 '20-24, SP 570 '22-24, CREW SP 570 '22-24, XP KINETIC '23-24



EASILY ADD LIGHTING

With Polaris PULSE it's easy to add RIGID® and Pro Armor lighting to your RANGER. All LED Light bars listed on pages 94-95 are Polaris PULSE ready, making installation that much easier.

POLARIS PULSE LIGHT BAR WIRING LOCATIONS

Front Bumper Roof - Front Mounted
Roof - Rear Mounted *CREW Roof - Rear Mounted

*Requires Extension

	XD 1500	1000 / XP 1000 / XP KINETIC	SP 570
1 LIGHT WITH 1 SWITCH			
PULSE Light Bar Harness - Dash Switched 2889738 -OR- Overhead Switch Panel Kit 2880422 PULSE Light Bar Harness - Upper Switch Panel 2889686	TOP SELLER Polaris PULSE Wiring Harness - 1 LED Light Bar 2883230 Upper Switch Panel Light Bar Harness** 2889675	Polaris PULSE Wiring Harness - 1 LED Light Bar 2889161	
2 LIGHTS WITH 1 SWITCH			
PULSE Light Bar Harness - Dash Switched 2889738 Y-Harness 2879860 -OR- Overhead Switch Panel Kit 2880422 PULSE Light Bar Harness - Upper Switch Panel 2889686 Y-Harness 2879860	TOP SELLER Polaris PULSE Wiring Harness - 1 LED Light Bar 2883230 Y-Harness 2879860	N/A	
2 LIGHTS WITH 2 SWITCHES			
PULSE Light Bar Harness - Dash Switched (x2) 2889738 -OR- Overhead Switch Panel Kit 2880422 PULSE Light Bar Harness - Upper Switch Panel (x2) 2889686	TOP SELLER Polaris PULSE Wiring Harness - 1 LED Light Bar (x2) 2883230	Polaris PULSE Wiring Harness - 1 LED Light Bar (x2) 2889161	
EXTENSIONS FOR CREW			
N/A	Polaris PULSE Wiring Harness - 1 LED Light Bar - Crew Extension 2883231 Upper Switch Panel Light Bar Harness - Extension** 2890067	N/A	

**Check with your local dealer for availability.

TRACKS

PROSPECTOR PRO TRACK SYSTEM

PROSPECTOR PRO TRACK MOUNT KIT

• Install this track system mounting hardware in place of tyres and wheels. Tracks sold separately.

» 2889425

XP 1000 '21-24, CREW XP 1000 '21, CREW 1000 '20-24, 1000 '21-24. FITS MODELS WITH NON-HIGH CLEARANCE A-ARMS

» 2889426

XP 1000 '21-24, CREW XP 1000 '21-24. FITS MODELS WITH HIGH CLEARANCE A-ARMS

» 2882783

XP 1000 '18-21, CREW XP 1000 '19-21, CREW 1000 '20-21, 1000 '20-21

» 2880071

CREW 570-4 '15-21, 570 '14-21, 500 '17-24

» 2889196

SP 570 '22-24
REQUIRES PROSPECTOR PRO TRACK (2880758), SOLD SEPARATELY

PROSPECTOR PRO 2.0 TRACK

» 2890034

XP 1000 '18-24, CREW XP 1000 '18-24, CREW 1000 '20-24, 1000 '20-24

» 2889487

SP 570 '22-24, CREW SP 570 '22-24

PROSPECTOR PRO TRACK

» 2880758

570 '14-21 WITH EPS, CREW 570 '14-21 WITH EPS

» 2880757

CREW 570-4 '14-21, 570 '14-21, 500 '17-24

If using Glacier Pro Plow System with tracks, Track Plow Extension is required (2889267)

For year-round use, Polaris recommends the use of Intake Update Kit (2880673) on any RANGER XP 1000 '17, RANGER XP 1000 CREW '14-18 with tracks installed. To keep intake system working optimally, this kit pre-filters out fine snow and dust.



1 INDUSTRY-FIRST FLEX-TRACK DESIGN

Front-mounted tracks with flexible sides and a slight inward curve allow for stable handling, a more comfortable ride and precise steering over long-distances or extended working hours.

2 HIGH-DENSITY TYRE WITH ADJUSTED SHAPE

With puncture-proof tyres that reduce friction and wear, the Prospector Pro 2.0 Tracks delivers trouble-free performance.

Confidently take on bumps and obstacles with 8" high-density tracks.

3 LIGHTWEIGHT POWDER COAT STEEL FRAME

Proven geometry to improve durability and deliver capability in all conditions throughout the life of the tracks.

A lighter frame provides more flotation to stay on top of the snow and allows the tracks to easily shed the elements they encounter.

4 TANDEM STABILIZER

The bolt-on, tandem mid-roller wheel provides a smoother ride by absorbing shocks.

5 BEARING HOUSING

Outer seals and stainless steel sleeves allow stronger bearing durability and greater reliability.

6 WHEEL CAP & SEAL

A fitted wheel cap with bladder effect eliminates water absorption due to temperature variation. Ride in snow or mud without worrying about track maintenance.

PROTECTING YOUR ESSENTIAL GEAR SINCE 1943

KOLPIN STRONGHOLD SYSTEM

Polaris is proud to partner with Kolpin Outdoors, an industry leader in off-road accessories and the premier name in gun boots and mounts. If you need to secure a firearm while riding, simply attach the auto-latch mount and choose your Gun Boot.

IDEAL FOR SECURE TRANSPORT OF SCOPED RIFLES AND SHOTGUNS.

STEP 1 CHOOSE YOUR MOUNT



STEP 2 CHOOSE YOUR BOOTS



LR LOCK & RIDE KOLPIN STRONGHOLD AUTO-LATCH DOUBLE BOOT MOUNT

- Precision angle adjustable for a custom fit
- Provides a quick and secure attachment point
- » DOUBLE BOOT MOUNT • 2883970
- » SINGLE BOOT MOUNT • 2884106



RHINO-RACK - GUN BOOT MOUNT

- Bracket used to mount Kolpin Stronghold Gun Boots to Rhino-Rack systems when paired with Auto-Latch Mount (2884106), sold separately
- » 2889327
- XP 1000 '18-24, CREW XP 1000 '19-24, CREW 1000 '20-24, 1000 '20-24, XD 1500 '24, CREW XD 1500 '24
- REQUIRES AUTO-LATCH MOUNT 2884106 TO MOUNT TO VEHICLE
- SEE P. 56 FOR MORE RHINO-RACK PRODUCTS



KOLPIN STRONGHOLD GUN BOOT XL

- Lockable and TSA approved
- Includes padded, zippered internal protective liner
- 132 cm L x 9.5 cm W x 26.7 cm H
- » 2882036
- REQUIRES AUTO-LATCH MOUNT 2883970 OR 2884106 TO MOUNT TO VEHICLE

KOLPIN STRONGHOLD GUN BOOT L

- 132 cm L x 12 cm W x 23.5 cm H
- » 2882426
- REQUIRES AUTO-LATCH MOUNT 2883970 OR 2884106 TO MOUNT TO VEHICLE

LR LOCK & RIDE GUN RACK 6

- Adjustable to store guns at an angle or vertical (shown at angle)
- Holds six rifles or shotguns securely with soft rubber v-grips
- Stock is secured in place with a soft molded rubber inlay along the bottom of the rack
- Rack can be adjusted into three positions based on firearm height
- » 2882159
- XP 1000 '17-22, CREW XP 1000 '18-22, CREW 570 FULL SIZE '18-22, CREW 1000 '20-22, 570 FULL SIZE '17-22, 1000 '20-22



IN-CAB GUN MOUNT

- Gives you instant gun access in the field
- Mounts securely to the floor and adjusts up to 45° forward
- Robust, molded gun butt holder at base
- Quick-release barrel straps
- Easily removable
- Accommodates scope-equipped rifles
- » 2883263
- XP 1000 '18-22, CREW XP 1000 '19-22, CREW 1000 '20-22, 1000 '20-22
- NORTHSTAR EDITION REQUIRES 2208023 HWD KIT TO INSTALL ON THE 2019 AND NEWER MODELS



ADD A REAR WINCH SO YOUR RANGER WORKS HARDER THAN YOU DO

XD 1500 P. 31

RANGER 1000 / XP 1000 P. 59

RANGER SP 570 P. 73



**KOLPIN RHINO GRIPS
IDEAL FOR CARRYING RIFLES,
SHOTGUNS, BOWS AND CROSSBOWS**



RHINO GRIP PRO

» 2884107

» REPLACEMENT RUBBER STRAPS (2) • 2884109

ALL RANGER MODELS (EXCEPT 150 EFI)



RATCHETING RHINO GRIP

» 2881575

ALL RANGER MODELS (EXCEPT 150 EFI)



RHINO GRIP XLR

» 2889165

» REPLACEMENT RUBBER STRAPS (2) • 2889204

ALL RANGER MODELS (EXCEPT 150 EFI)



RHINO GRIP XLR - DOUBLES

» 2889166

» REPLACEMENT RUBBER STRAPS (2) • 2889204

ALL RANGER MODELS (EXCEPT 150 EFI)



POLARIS PURSUIT CAMO SxS FIELD COVER

- Full-coverage camo print cover hides your side-by-side while in the field
- Lightweight material protects your RANGER from inclement weather

» 2882160

XP 1000 '18-24, EV '11-24, 570 FULL SIZE '17-24, 570 '14-21, SP 570 '22-24, 500 '11-24, 1000 '20-24, XD 1500 24

Never transport a loaded firearm. Verify firearm is unloaded prior to mounting. Please refer to local laws and regulations regarding the requirements for the legal transport of firearms.

WINCHES

DEPENDABLE. TOUGH. BUILT FOR THE OFF-ROAD.

A Polaris Engineered winch is designed to help you get the job done right, get you on your way faster and prepare you for the unexpected.

WHY POLARIS?

Polaris Off Road vehicles are engineered with designated mounting points and wiring for seamless install of Polaris Engineered winches.



TESTED **1,200+**
PULLS AT MAX LOAD



BUILT TO WITHSTAND
-29° C TEMPERATURES



OPERATES
FULLY SUBMERGED



MILITARY
TESTED & APPROVED

UPGRADE YOUR CONTROLS

DASH WINCH SWITCH KIT

- Allows user to add a dash switch as an additional means to control winch
- Compatible with all winches and other control methods (wireless/wired)

» 2889050

XD 1500 '24, CREW XD 1500 '24, XP 1000 '18-24, CREW XP 1000 '19-24, CREW 1000 '20-24, 1000 '20-24, XP KINETIC '23-24

TOP SELLER POWER CONTROLLER

- Control winch/plow hydraulics from shift knob

» 2883247 (SHOWN)

XP 1000 '18-24, CREW XP 1000 '19-24, CREW 1000 '20-24, 1000 '20-24, XP KINETIC '23-24

REQUIRES WINCH ADAPTER (2884159), SOLD SEPARATELY, WHEN USING A WINCH FOR LIFTING DEVICE

» 2889162

SP 570 '22-24

» 2879227

EV '11-24, CREW 570-4 '14-21, 570 FULL SIZE '17-24, 570 '14-21, 500 '11-24

» **NEW** 2889769 LATE AVAILABILITY

XD 1500 '24, CREW XD 1500 '24

WIRED REMOTE CONTROL

- Handle and socket both required

» REMOTE HANDLE • 4013466

» SOCKET • 4017102

WORKS WITH 2882714

» SOCKET • 4014228

WORKS WITH 2885095 & 2881669

REPLACEMENT PARTS

SYNTHETIC ROPE

» 2,722 KG
2879188

» 1,588 KG
2879187



STEEL CABLE

» 1,588 KG
2878890



ADD A PLOW P. 54

FEATURES & BENEFITS

ALL POLARIS ENGINEERED WINCHES COME WITH:

- ✓ INTEGRATED WIRING, MOUNT, PREASSEMBLED
- ✓ HOOK WITH STRAP
- ✓ CUT STEEL GEARS & SEALED DRIVETRAIN
- ✓ SEALED PERMANENT MAGNET MOTOR



Retrieve cable 5x as fast as standard mode on other Polaris winches. Get back to riding or complete your task quicker.

1. Set winch dial to N (Neutral) to manually pull the rope out and secure the hook to your anchor point
2. Set winch dial to L (Low) for maximum pulling power while winching your load
3. Set winch dial to H (High) for retrieving the rope 5x faster with Rapid Rope Recovery

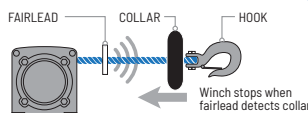

Auto Stop technology protects and extends the life of your winch by automatically stopping the winch at the end of pull to prevent over-spooling. While plowing, it prevents the plow frame from bending by stopping the winch once the plow has been lifted.



With its lightweight, yet extremely strong, design and superior flexibility, this 15.2 m long synthetic rope is easy to handle and can stand up to any tough job.



This convenient remote operates your Polaris winch wirelessly from within 15.2 m of the vehicle. Operate your winch safely outside your vehicle while on the job site or trails.

MODEL

XD 1500 '24
CREW XD 1500 '24

XP 1000/CREW XP 1000 '18-24
1000/CREW 1000 '20-24
XP KINETIC '23-24

NON EPS RANGER 1000 REQUIRES FRONT BUMPER

SP 570/CREW SP 570 '22-24

2-SEAT & CREW MODELS REQUIRE CABLES: 2889185

570 FULL-SIZE/CREW 570 FULL-SIZE '16-24

REQUIRED CABLES: 3-SEAT MODELS: 2881684, CREW MODELS: 2880929

COMMON ACCESSORIES

CONNECTED TECHNOLOGY

ELECTRICAL ACCESSORIES

TRACKS

COOLERS

HUNT

WINCHES

LIGHTING

WHEELS & TYRES



TOP-OF-THE-LINE FEATURES

BEST FOR PLOWING, HEAVY-DUTY OUTDOOR CHORES & TRAIL RIDING

PRO PRO HEAVY DUTY SERIES



BUILT FOR THE OFF-ROAD

BEST FOR THE CASUAL OFF-ROAD RIDER

HD HEAVY DUTY SERIES



NOT AVAILABLE



ADD AUTO STOP TECHNOLOGY

2883454
WORKS WITH 2882714 & 2889275
SYNTHETIC ROPE REQUIRED



2881693
WORKS WITH 2885095 & 2881669
SYNTHETIC ROPE REQUIRED

**AUTO STOP UPGRADE
+ WIRELESS REMOTE**
2890991

WORKS WITH 2889275
SYNTHETIC ROPE REQUIRED



ADD SYNTHETIC ROPE

2879187



2878888



ADD WIRELESS REMOTE

TOP SELLER **2883455**
WORKS WITH 2882714 & 2889275



2879316
WORKS WITH 2885095 & 2881669

**AUTO STOP UPGRADE
+ WIRELESS REMOTE**
2890991

WORKS WITH 2889275
SYNTHETIC ROPE REQUIRED

2,722 KG	2,041 KG	2,041 KG	1,588 KG
NEW 2889276		NEW 2889275	
TOP SELLER 2882710	TOP SELLER 2882711	TOP SELLER 2882714 High-Mounted 2889272	
	2885096		TOP SELLER 2885095
	2882238		TOP SELLER 2881669

ADVANCED TECH

RIGID lights are driven by Aluminum PCB Smart Boards, 6063-T5 aircraft aluminum extruded housings and Tiger Drylac UV protection polyester powdercoating.

EXCLUSIVE OPTICS

RIGID lights feature impact-resistant polycarbonate lenses for a 100% water/dustproof seal.

LIGHT BAR TYPES



SR-SERIES PRO

Sleek, powerful, low-profile (under 5 cm tall). Lights extreme distances with low energy usage.

Available in 25 cm & 81 cm



D-SERIES PRO

Compact to fit almost anywhere with high output and low energy usage.

Available in Driving, Flood & Spot

CONNECTED TECHNOLOGY

ELECTRICAL ACCESSORIES

TRACKS

COOLERS

HUNT

WINCHES

LIGHTING

WHEELS & TYRES

LIGHT BAR OPTIONS

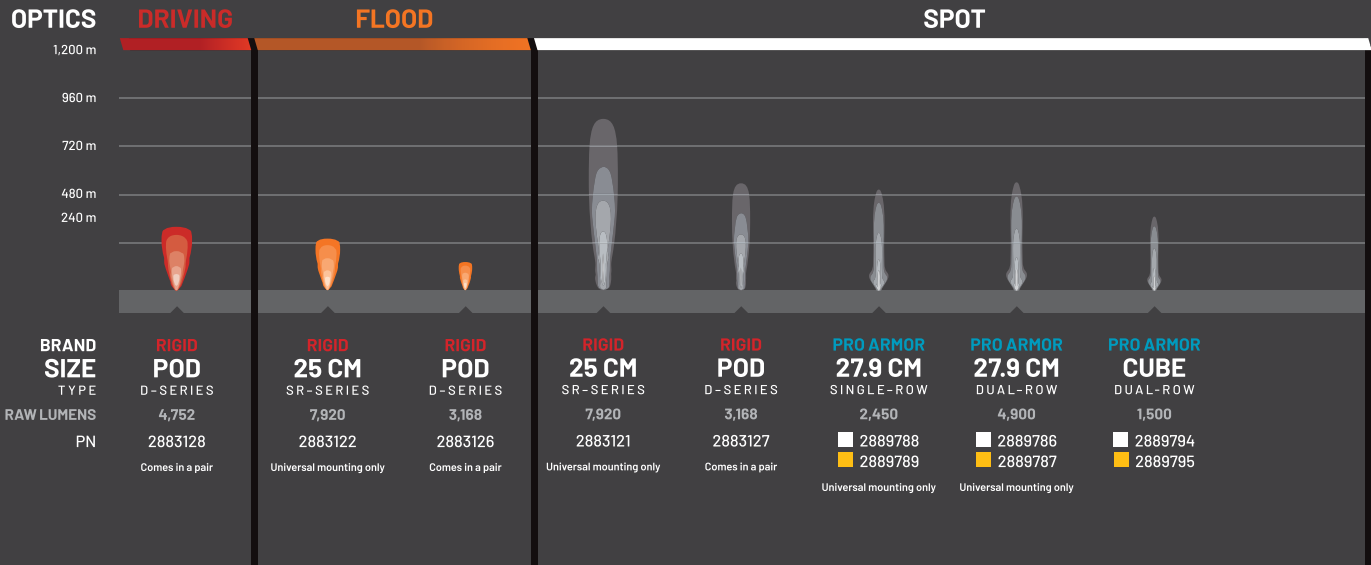

BUILD YOUR VISION

Consider the optics, angle and how you will use your vehicle to choose the right light or set of lights.

OPTICS LIGHT ANGLE	ACCENT	DRIVING (45°)	FLOOD (25°)	SPOT (10°)	COMBO (25°/10°)
DRIVING SPEED	All	Slow to medium	Slow to medium	High	All
BEAM	Diffused glow	Extra-wide	Wide/shorter	Concentrated/long	Inner spot & outer flood
RECOMMENDED MOUNTING	Low/wheel well	All points	Low/rear	High points	All points
TERRAIN & RIDING STYLE	Added style & personalization in any terrain	All riding & utility	Wide-open terrain or trails & utility	Trail & tight conditions	All riding & utility

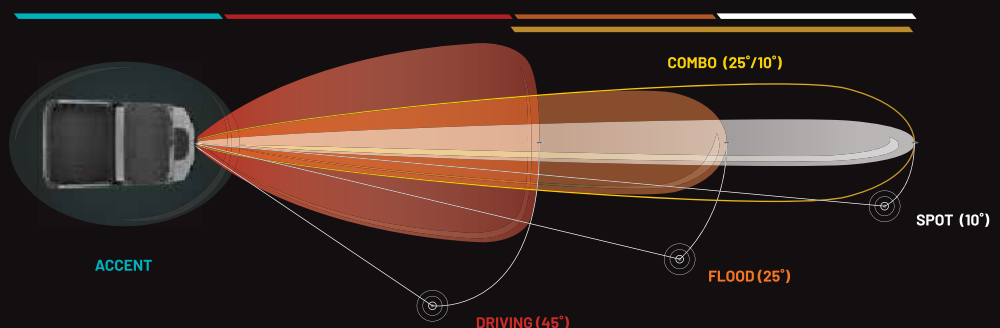

MAX PERFORMANCE
Validated to work as hard as your machine does

DOESN'T OVERTAX
Trust it to work when you need it to

PRO ARMOR



RUGGED CONSTRUCTION

Pro Armor lights are designed to be big and beefy with an aggressive style all their own, and housed in IP67 marine-grade rated UV polyester powdercoating.

MASSIVELY BRIGHT

Pro Armor builds bright lights designed for any riding experience. All that power is directed through heat dissipating aluminum for streamlined heat management

COMMON ACCESSORIES

CONNECTED TECHNOLOGY

ELECTRICAL ACCESSORIES

TRACKS

COOLERS

HUNT

WINCHES

LIGHTING

WHEELS & TYRES



DUAL-ROW LED

The most spread and farthest illumination downrange. Easy to mount.

Available in 27.9 cm & 78.7 cm



SINGLE-ROW LED

Powerful, compact, low-profile light bars with sleek look.

Available in 27.9 cm, 50.8 cm, 84 cm & 102 cm



CUBE LED

Small size allows mounting in strategic locations for added lighting.

Available in Spot

COMBO

OPTICS

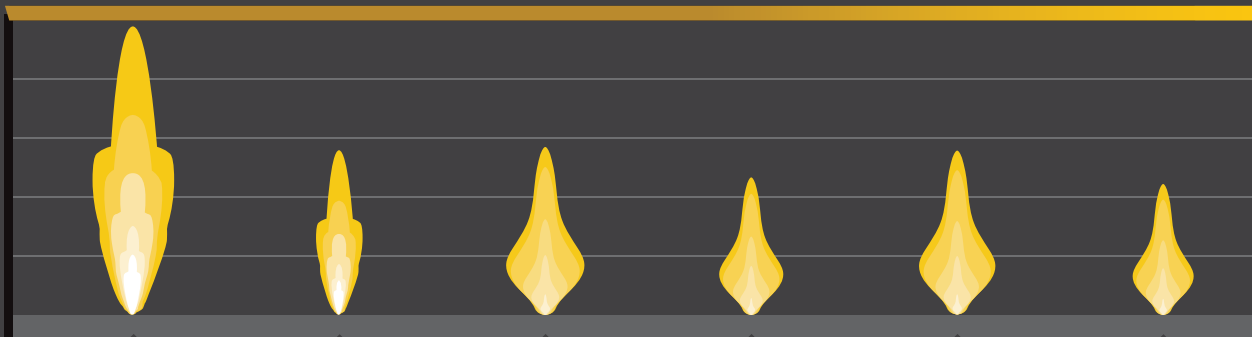

RIGID
81 CM
SR-SERIES
20,064
2884299

RIGID
25 CM
SR-SERIES
7,920
2883123

Universal mounting only

PRO ARMOR
102 CM
SINGLE-ROW
7,600
2889793

PRO ARMOR
84 CM
SINGLE-ROW
7,500
2889791

PRO ARMOR
78.7 CM
DUAL-ROW
13,500
2889790

PRO ARMOR
50.8 CM
SINGLE-ROW
4,700
2889792

BRAND SIZE
TYPE
RAW LUMENS
PN

ADD A HARNESS TO MOUNT YOUR LIGHTS

MODELS	LIGHT BAR SET-UPS	
	1 LIGHT IN 1 LOCATION ON 1 SWITCH	2 LIGHTS IN 2 LOCATIONS ON 1 SWITCH
EV '15-24 CREW 570-4 '15-21 CREW 570 FULL SIZE '18-24 570 FULL SIZE '17-24 570 '15-21 500 '17-24	<p>TOP SELLER</p> <p>LIGHT BAR HARNESS 2882209</p> <p>UPPER SWITCH PANEL LIGHT BAR HARNESS* 2889675</p> <p>⚠ REQUIRES BATTERY CONNECTION CABLE</p>	<p>TOP SELLER</p> <p>LIGHT BAR HARNESS 2882209</p> <p>Y-HARNESS 2879860</p> <p>⚠ REQUIRES BATTERY CONNECTION CABLE</p>
SP 570 '22-24 NON-PREMIUM AND NON-NORTHSTAR MODELS REQUIRE BATTERY CONNECTION CABLE	<p>SEE P. 80 FOR WIRING CONNECTIONS</p>	
XP 1000 '18-21 CREW XP 1000 '19-21 1000 '20-21 CREW 1000 '20-21 XP KINETIC '23-24		
XD 1500 '24, CREW XD 1500 '24		

▲ BATTERY CONNECTION CABLES

3-SEAT & CREW

- » 3-SEAT • 2879388
XP 1000 '17
- » CREW • 2879685
CREW XP 1000 '17-18

2-SEAT & CREW

- » **TOP SELLER** 2-SEAT • 2879990
EV '15-24, 570 '15-21, 500 '17-24
- » CREW • 2880929
CREW 570-4 '15-21
- » 570 • 2881684
EV '15-24, 570 '15-21, 500 '17-24
- » SP 570 • 2889185
SP 570 SPORT '22-24,
CREW SP 570 SPORT '22-24

1 LED LIGHT BAR WIRING HARNESS - REAR FACING CREW EXTENSION

- For installing rear facing light on Crew models
- » 2883854
XP 1000 '20-24, CREW XP 1000 '19-24,
CREW 1000 '20-24
TO BE USED WITH LIGHT BAR HARNESS (2889675)

LIGHT BAR MOUNT

- Optional cast mount for added style
- Compatible with all Pro Armor light bars
- » 2890053

NEW CAST LIGHT BAR MOUNT

- » 2889330
XD 1500 '24, CREW XD 1500 '24

ADD ADDITIONAL EXTERNAL LIGHTING P. 48

WHEELS & TYRES

COMMON ACCESSORIES

CONNECTED TECHNOLOGY

ELECTRICAL ACCESSORIES

TRACKS

COOLERS

HUNT

WINCHES

LIGHTING

WHEELS & TYRES



KNOW YOUR TYRES

DIMENSIONS			USAGE	TREAD DEPTH	TYRE WEIGHT	PLY RATING	SIDEWALL BELTS	LOAD RATING
29" x 11" R14			FRONT/REAR	16 mm	16 kg	8	3	599 kg
Part Number								
TYRE HEIGHT	TYRE WIDTH	WHEEL DIAMETER	Where can you use the tyre	Deeper treads have more grip in all conditions	A lighter tyre makes for improved vehicle performance	Indicates tyre puncture-resistance	Increase your resistance to sidewall punctures	How much weight can the tyre handle

WAYS TO SHOP >>>

TYRES BY SIZE



PRO ARMOR.

26"	27"	28"	29"	30"	32"
ATTACK	HARVESTER	ATTACK 2.0	DUAL-THREAT	ATTACK 2.0	ATTACK 2.0
DUAL-THREAT	MUD XC	CRAWLER XG	HD-K	CRAWLER AT	DUAL-THREAT
HARVESTER	PRESERVE	CRAWLER XR	MUD XC	CRAWLER XG	CRAWLER AT
PRESERVE	TREKKER	HARVESTER	TREKKER	CRAWLER XP	CRAWLER XG
TREKKER	X TERRAIN		X TERRAIN	CRAWLER XR	CRAWLER XP
XD-K				HARVESTER	CRAWLER XR
				MUD XC	HARVESTER
				PRO RUNNER	PRO RUNNER
				TREKKER	TREKKER

SUPERIOR PERFORMANCE & DURABILITY

LIFELONG PERFORMANCE

- Every tyre is designed and constructed with longevity in mind
- 3,000+ mile rated (4,828 kilometers)

PREMIUM PROTECTION

- Pro Armor makes tyres with extra protection exactly where it's needed most – the sidewall
- Triple-belted sidewalls keep your tyres more resistant so you can keep going

TOUGH TYRES

- Higher ply ratings mean added protection
- Pro Armor builds 8 or 10-ply rated tyres for higher puncture-resistance

KNOW YOUR TERRAIN



- Tread patterns optimized for extreme traction
- Ideal for both hard pack & loose trail



- Provides traction & durability
- Performs in hard sand, jagged rocks or any extreme terrain



- Flexible "grippy" tread
- Aggressive side bite



- Extra deep treads
- Self-cleaning lugs



- Triple-belted sidewalls to resist puncture
- Purpose-built, long lasting tread patterns



- Handles extreme cold
- Holds shape & provides traction

KNOW YOUR WHEELS

STEP 1: SELECT YOUR SERIES

4 = 40-SERIES 5 = 50-SERIES

STEP 2: CHOOSE YOUR LOAD RATING

1 = <362.9 KG 2 = 363 - 589.7 KG 3 = 590 - 726+ KG

STEP 3: PICK YOUR STYLE

OFFSET / BEADLOCK / COLOR

INCREASE OFFSET FROM STOCK = NARROWER STANCE

DECREASE OFFSET FROM STOCK = WIDER STANCE

TYRES BY SIZE

TRAIL	ROCK	DESERT	MUD	UTILITY	SNOW
ATTACK	ATTACK 2.0	ATTACK	MUD XC	HARVESTER	ATTACK
ATTACK 2.0	CRAWLER AT	ATTACK 2.0		HD-K	ATTACK 2.0
CRAWLER AT	CRAWLER XG	CRAWLER AT		PRESERVE	HARVESTER
CRAWLER XG	CRAWLER XP	CRAWLER XG		TREKKER	HD-K
CRAWLER XP	CRAWLER XR	CRAWLER XP		XD-K	XD-K
CRAWLER XR	DUAL-THREAT	CRAWLER XR		X TERRAIN	
DUAL-THREAT	PRO RUNNER	DUAL-THREAT			
HARVESTER		PRO RUNNER			
HD-K					
MUD XC					
PRESERVE					
PRO RUNNER					
TREKKER					
XD-K					
X TERRAIN					

WHEELS BY SIZE

14"	15"
40-SERIES (20 TYRE OPTIONS)	50-SERIES (20 TYRE OPTIONS)
4201	5201
4202	5202
4203 BEADLOCK	5203 BEADLOCK
4204	5204
4205	5206
4301 BEADLOCK	5301 BEADLOCK
HD DUAL BEADLOCK	5304 BEADLOCK
	5306
	5307
	5307 BEADLOCK

TYRES

PICKING THE RIGHT UTILITY TYRE

COMMON ACCESSORIES

CONNECTED TECHNOLOGY

ELECTRICAL ACCESSORIES

TRACKS

COOLERS

HUNT

WINCHES

LIGHTING

WHEELS & TYRES

UTILITY FEATURE

UTILITY FEATURE	X TERRAIN	PRESERVE	HARVESTER	XD-K	HD-K
8,047 Kilometer Rated Long life and performance	X	X	X		
10-Ply Rated Higher ply ratings means added protection		X	X	X	X
Low Impact Tread Easy on soil		X			
Heavy-Duty Tread Aggressive tread pattern for all day work on farms or ranches	X		X	X	X
Turf-Friendly Easy on grass and farm yard	X	X	X		
Aramid Fiber Belt 5x times stronger than steel and lighter				X	X
Size Options For exactly how you want to use your machine	27", 29"	26", 27"	26", 27", 28" 30", 32"	26"	29"



FRONT/REAR

X TERRAIN

- Built to perform through the toughest obstacles on any trail
- Durability-driven design to provide a comfortable, confident ride
- 8-ply, triple-belted ballistic sidewalls resist punctures

	TREAD DEPTH	TYRE WEIGHT	PLY RATING	SIDEWALL BELTS	LOAD RATING
14" 27" x 9" R14 5418330	16 mm	12 kg	8	3	365 kg
14" 27" x 11" R14 5418331		14 kg			438 kg
14" 29" x 9" R14 5418332		14 kg			499 kg
14" 29" x 11" R14 5418333		16 kg			599 kg



WHEEL SIZE

14"



FRONT/REAR

PRO ARMOR PRESERVE

- Turf-friendly for areas where low-impact from tyre tread is needed
- Rounded profile and special tread pattern to limit footprint

	TREAD DEPTH	TYRE WEIGHT	PLY RATING	SIDEWALL BELTS	LOAD RATING
12" 26" x 8" R12 5416403	16 mm	11 kg	10	3	388 kg
12" 26" x 10" R12 5416402		13 kg			599 kg
14" 27" x 10" R14 5416348		13 kg			599 kg



WHEEL SIZE

12" 14"



UTILITY



TRAIL



SNOW

FRONT/REAR

PRO ARMOR HARVESTER

- All-around work horse with tread life of 8,047 km
- Tread pattern designed to withstand anything from the farmyard to the pastures and the trail
- With 10-ply, it can carry the load day in and day out

			TREAD DEPTH	TYRE WEIGHT	PLY RATING	SIDEWALL BELTS	LOAD RATING
12"	26" x 8" R12 5416396	FRONT	16 mm	11 kg	10	3	388 kg
12"	26" x 10" R12 5415966	REAR		15 kg			615 kg
14"	27" x 10" R14 5415965	FRONT/ REAR		15 kg			599 kg
14"	28" x 10" R14 5416347	FRONT/ REAR		15 kg			630 kg
15"	NEW 30" x 10" R15 5417529	FRONT/ REAR		17 kg			599 kg
15"	NEW 32" x 10" R15 5418256	FRONT/ REAR		20 kg			XXX kg

* Fits XD 1500 / Crew XD 1500 only



WHEEL SIZE

12"

14"

15"



UTILITY



TRAIL



SNOW

FRONT/REAR

PRO ARMOR XD-K

- 26" Aramid fiber-belted tyre to tackle any terrain
- Unique full-face tread design
- Harder durometer lugs promotes extended wear, increasing tyre life

			TREAD DEPTH	TYRE WEIGHT	PLY RATING	SIDEWALL BELTS	LOAD RATING
12"	26" x 9" R12 5415756	FRONT	31.7 mm	13 kg	10	3/1 Aramid Fiber Belt	388 kg
12"	26" x 11" R12 5415757	REAR		15 kg			499 kg



WHEEL SIZE

12"



UTILITY



TRAIL



SNOW

FRONT/REAR

PRO ARMOR HD-K

- Designed to provide a smooth ride and aggressive traction in all riding terrains
- Triple-belted sidewall provides extreme protection and extends the tyre life
- Quad belt tread core offers superior protection and longer tread life

			TREAD DEPTH	TYRE WEIGHT	PLY RATING	SIDEWALL BELTS	LOAD RATING
14"	29" x 10" R14 5417507	FRONT/ REAR	31.75 mm	18 kg	10	3/1 Aramid	598 kg



WHEEL SIZE

14"

TYRES



FRONT/REAR

PRO ARMOR CRAWLER XR

- Premium grip for all terrains, from the trail to the rocks
- Square block profile for even surface contact
- A tougher durometer than the XG to take on the toughest the trail has to offer

	TREAD DEPTH	TYRE WEIGHT	PLY RATING	SIDEWALL BELTS	LOAD RATING
14" (FRONT/REAR) 28" x 10" R14 5415536	16 mm	15 kg	8	3	517 kg
15" (FRONT/REAR) 30" x 10" R15* 5418254		16.8 kg			581 kg
15" (FRONT/REAR) 32" x 10" R15* 5416114		18 kg			630 kg

* Fits XD 1500 / Crew XD 1500 only



WHEEL SIZE

14"

15"



FRONT/REAR

NEW PRO ARMOR CRAWLER AT

- Directional tread for optimal performance
- Greater lug separation for easy mud clean out
- 8-ply, triple-belted ballistic sidewalls resist punctures

	TREAD DEPTH	TYRE WEIGHT	PLY RATING	SIDEWALL BELTS	LOAD RATING
15" (FRONT/REAR) 30" x 10" R15 5417534	18 mm	16 kg	8	3	580 kg
15" (FRONT/REAR) 32" x 10" R15 5417535		18 kg			630 kg

* Fits XD 1500 / Crew XD 1500 only



WHEEL SIZE

15"

WHAT CRAWLER ARE YOU?



XR

SINGLE DUROMETER

- Smaller lug height and single durometer gives this high-speed tyre added rigidity and lateral stability when cornering
- Unique lug design excels in hard-pack, fast terrain



AT

DIRECTIONAL LUG PATTERN

- The same taller lug height as Crawler XG, providing more grip and better traction
- Wider lug spacing for excellent mud clean-out

COMMON ACCESSORIES

CONNECTED TECHNOLOGY

ELECTRICAL ACCESSORIES

TRACKS

COOLERS

HUNT

WINCHES

LIGHTING

WHEELS & TYRES

TYRES



FRONT/REAR

PRO ARMOR CRAWLER XG

- Built to crawl over all obstacles, both large and small
- A soft, sticky compound makes this tyre ideal for both rock crawling and desert running
- 8-ply, triple-belted ballistic sidewalls resist punctures

		TREAD DEPTH	TYRE WEIGHT	PLY RATING	SIDEWALL BELTS	LOAD RATING
15"	28" x 10" R15 5416346	20 mm	15 kg	8	3	499 kg
15"	30" x 10" R15* 5416397		18 kg			581 kg
15"	32" x 10" R15* 5416699		19 kg			630 kg

* Fits XD 1500 / Crew XD 1500 only



WHEEL SIZE

15"

COMMON ACCESSORIES

CONNECTED TECHNOLOGY

ELECTRICAL ACCESSORIES

TRACKS

COOLERS

HUNT

WINCHES

LIGHTING

WHEELS & TYRES



FRONT/REAR

NEW

PRO ARMOR CRAWLER XP

- Ideal for overlanding, rock crawling and desert running with a soft, sticky compound
- Built to maneuver over large and small obstacles
- 8-ply, triple-belted ballistic sidewalls with anti-puncture strength

		TREAD DEPTH	TYRE WEIGHT	PLY RATING	SIDEWALL BELTS	LOAD RATING
15"	30" x 10" R15 5418329	20 mm	17 kg	8	3	580 kg
15"	32" x 10" R15 5418110		19 kg			630 kg

* Fits XD 1500 / Crew XD 1500 only



WHEEL SIZE

15"



XR

SINGLE DUROMETER

- Smaller lug height and single durometer gives this high-speed tyre added rigidity and lateral stability when cornering
- Unique lug design excels in hard-pack, fast terrain



AT

DIRECTIONAL LUG PATTERN

- The same taller lug height as Crawler XG, providing more grip and better traction
- Wider lug spacing for excellent mud clean-out

TYRES



FRONT/REAR

PRO ARMOR ATTACK

- The best all-purpose tyre for all-season traction in any terrain
- Unique, full-face tread design
- Harder durometer lugs promote extended wear, increasing tyre life
- Wider spaced lugs provide more grip in softer terrain

	TYRE SIZE	TYRE WEIGHT	PLY RATING	SIDEWALL BELTS	LOAD RATING
14"	26" x 9" R14 5415613	13 kg	8	3	413 kg
	26" x 11" R14 5415614	15 kg			599 kg

TREAD DEPTH
23 mm

WHEEL SIZE

14"



FRONT/REAR

PRO ARMOR ATTACK 2.0

- Engineered for excellent hard pack performance
- Dual-compound technology and radial construction offer performance in all terrains
- Tight tread pattern for quieter ride

	TYRE SIZE	TYRE WEIGHT	PLY RATING	SIDEWALL BELTS	LOAD RATING
15"	28" x 10" R15 5416344	17 kg	10	3	560 kg
	30" x 10" R15 5416345				630 kg
	32" x 10" R15 5418252	20 kg			630 kg

TREAD DEPTH
25 mm

WHEEL SIZE

15"



* Fits XD 1500 / Crew XD 1500 only

TIGHTER TREAD PATTERN

Better traction in hard pack

DUAL-DUROMETER LUG

Increased grip & traction in rough terrain, smoother ride in all terrain

10-PLY RATED

Increased durability

LARGER SIZE OFFERING IN 28"

More ground clearance & trail traction



FRONT/REAR

PRO ARMOR TREKKER

- Specialized tread design provides a quiet ride
- Graduated lug depth maximizes the contact patch for ultimate predictability
- 8-ply, triple belted nylon construction

	TYRE SIZE	TYRE WEIGHT	PLY RATING	SIDEWALL BELTS	LOAD RATING	
12" 14" 14" 15"	26" x 10" R12 5418673	11-17 mm graduated	8	3	490 kg	
	27" x 10" R14 5418674				13 kg	547 kg
	29" x 10" R14 5418675				15 kg	560 kg
	30" x 10" R15 5418676				15 kg	631 kg
	32" x 10" R15 5418677				17 kg	631 kg

TREAD DEPTH
11-17 mm graduated

WHEEL SIZE

12" 14" 15"



* Fits XD 1500 / Crew XD 1500 only

COMMON ACCESSORIES

CONNECTED TECHNOLOGY

ELECTRICAL ACCESSORIES

TRACKS

COOLERS

HUNT

WINCHES

LIGHTING

WHEELS & TYRES



FRONT/REAR

PRO ARMOR PRO RUNNER

- Designed to be lightweight, high-performance and quicker in corners/flats
- Triple-belted sidewalls offer extra protection where it's needed the most
- Lug separation provides a great grip and an easy clean in mud and sand

WHEEL SIZE	TYRE SIZE	TREAD DEPTH	TYRE WEIGHT	PLY RATING	SIDEWALL BELTS	LOAD RATING
						LOAD RATING
15"	30" x 9" R15 5417531	14 mm	16 kg	8	3	630 kg
15"	32" x 9.5" R15 5417532					

* Fits XD 1500 / Crew XD 1500 only



WHEEL SIZE

15"



FRONT/REAR

PRO ARMOR MUD XC

- Designed as the perfect mud-trail crossover for a smooth ride on the trail and aggressive traction in the mud
- Dual-compound technology with harder durometer lugs promote extended wear, increasing tyre life
- 10-ply construction means added protection in the toughest terrain

WHEEL SIZE	TYRE SIZE	TREAD DEPTH	TYRE WEIGHT	PLY RATING	SIDEWALL BELTS	LOAD RATING	
						LOAD RATING	
14"	27" x 9" R14 5416947	30 mm	15 kg	10	3	599 kg	
14"	27" x 11" R14 5416948						FRONT
14"	29" x 10" R14 5416946						REAR
15"	30" x 10" R15 5418253						FRONT/REAR

* Fits XD 1500 / Crew XD 1500 only



WHEEL SIZE

14" 15"

DUAL-COMPOUND = MORE GRIP + LONGER LIFE

Firmier Durometer Rubber = Longer Life



Softer Durometer Rubber = More Grip



FRONT/REAR

PRO ARMOR DUAL-THREAT

- Dual-compound technology and radial construction offer performance in all terrains
- Softer durometer rubber on outer edge for overall superior grip and feel
- Harder durometer rubber in the middle for increased traction during acceleration and longer tread life

WHEEL SIZE	TYRE SIZE	TREAD DEPTH	TYRE WEIGHT	PLY RATING	SIDEWALL BELTS	LOAD RATING	
						LOAD RATING	
14"	26" x 9" R14 5416340	16 mm	14 kg	10	3	504 kg	
14"	26" x 11" R14 5416341						FRONT
14"	29" x 9" R14 5416342						REAR
14"	29" x 11" R14 5416343						FRONT
15"	32" x 10" R15 5416753						REAR

* Fits XD 1500 / Crew XD 1500 only



WHEEL SIZE

14" 15"

WHEELS



15"

50-SERIES

A 5201

WEIGHT: 7.8 KG LOAD RATING: 590 KG OFFSET: +4

ACCENT	FRONT/REAR	15" x 7"	1523184-266
MATTE BLACK	FRONT/REAR	15" x 7"	1523184-458

B 5202

WEIGHT: 8.1 KG LOAD RATING: 590 KG OFFSET: +4

ACCENT	FRONT/REAR	15" x 7"	1523102-266
MATTE BLACK	FRONT/REAR	15" x 7"	1523102-458

C 5203 BEADLOCK

WEIGHT: 7.3 KG LOAD RATING: 590 KG OFFSET: +38

MATTE BLACK	FRONT/REAR	15" x 7"	1522435-458
-------------	------------	----------	-------------

D 5204

WEIGHT: 6.1 KG LOAD RATING: 590 KG OFFSET: +55

MATTE BLACK	FRONT/REAR	15" x 7"	1522550-458
-------------	------------	----------	-------------

E 5206

WEIGHT: 6.1 KG LOAD RATING: 590 KG OFFSET: +55

MATTE BLACK	FRONT/REAR	15" x 7"	1524041
ONLY COMPATIBLE WITH XD 1500 / CREW XD 1500			

F 5301 BEADLOCK

WEIGHT: 7.7 KG LOAD RATING: 726 KG OFFSET: +38

ACCENT	FRONT/REAR	15" x 7"	1523282
MATTE BLACK	FRONT/REAR	15" x 7"	1523266

G 5304 BEADLOCK

WEIGHT: 7.3 KG LOAD RATING: 726 KG OFFSET: +62

MATTE BLACK	FRONT/REAR	15" x 7"	1525420
ONLY COMPATIBLE WITH XD 1500 / CREW XD 1500			

H 5306

WEIGHT: 6.8 KG LOAD RATING: 789 KG OFFSET: +62

MATTE BLACK	FRONT/REAR	15" x 7"	1525684
ONLY COMPATIBLE WITH XD 1500 / CREW XD 1500			

I 5307

WEIGHT: 7.3 KG LOAD RATING: 789 KG OFFSET: +62

MATTE BLACK	FRONT/REAR	15" x 7"	1525686
ONLY COMPATIBLE WITH XD 1500 / CREW XD 1500			

J 5307 BEADLOCK

WEIGHT: 8.2 KG LOAD RATING: 789 KG OFFSET: +62

MATTE BLACK	FRONT/REAR	15" x 7"	1525688
ONLY COMPATIBLE WITH XD 1500 / CREW XD 1500			

○ LUG NUTS REQUIRED P. 107

Ⓜ WHEELS WITH 5 LUG NUTS Only compatible with XD 1500 / Crew XD 1500.

KNOW YOUR WHEELS

STEP 1: SELECT YOUR SERIES

4 = 40-SERIES 5 = 50-SERIES

STEP 2: CHOOSE YOUR LOAD RATING

1 = <362.9 kg 2 = 363 - 589.7 kg 3 = 590 - 726+ kg

STEP 3: PICK YOUR STYLE

OFFSET / BEADLOCK / COLOR

INCREASE OFFSET FROM STOCK = NARROWER STANCE
DECREASE OFFSET FROM STOCK = WIDER STANCE

COMMON ACCESSORIES

CONNECTED TECHNOLOGY

ELECTRICAL ACCESSORIES

TRACKS

COOLERS

HUNT

WINCHES

LIGHTING

WHEELS & TYRES



K



L



M



N

BEADLOCK REQUIRED



O



P



Q

BEADLOCK INCLUDED

INNER AND OUTER
BEADLOCK INCLUDED

14"

40-SERIES

K 4201 ○

	FRONT	WEIGHT: 5.9 KG	LOAD RATING: 408 KG	OFFSET: +9
REAR		WEIGHT: 6.4 KG	LOAD RATING: 590 KG	OFFSET: +9
ACCENT	FRONT	14" x 7"	1522956-266	
	REAR	14" x 8"	1522957-266	
MATTE BLACK	FRONT	14" x 7"	1522956-458	
	REAR	14" x 8"	1522957-458	

L 4202 ○

	FRONT	WEIGHT: 5.8 KG	LOAD RATING: 408 KG	OFFSET: +4
REAR		WEIGHT: 6.1 KG	LOAD RATING: 590 KG	OFFSET: -9
ACCENT	FRONT	14" x 7"	1522544-266	
	REAR	14" x 8"	1522545-266	
MATTE BLACK	FRONT	14" x 7"	1522544-458	
	REAR	14" x 8"	1522545-458	

M 4203 BEADLOCK ○ ○

	FRONT	WEIGHT: 5.9 KG	LOAD RATING: 408 KG	OFFSET: +4
REAR		WEIGHT: 6.6 KG	LOAD RATING: 590 KG	OFFSET: -9
MATTE BLACK	FRONT	14" x 7"	1522238-458	
	REAR	14" x 8"	1522239-458	

N 4204 ○

	FRONT	WEIGHT: 5.9 KG	LOAD RATING: 408 KG	OFFSET: +4
REAR		WEIGHT: 6.4 KG	LOAD RATING: 590 KG	OFFSET: -9
ACCENT	FRONT	14" x 7"	1522546-266	
	REAR	14" x 8"	1522547-266	
MATTE BLACK	FRONT	14" x 7"	1522546-458	
	REAR	14" x 8"	1522547-458	

O 4205 ○

	FRONT	WEIGHT: 4.8 KG	LOAD RATING: 408 KG	OFFSET: +4
REAR		WEIGHT: 5.7 KG	LOAD RATING: 590 KG	OFFSET: -9
MATTE BLACK	FRONT	14" x 7"	1521507-521	
	REAR	14" x 8"	1521508-521	
LUSTER	FRONT	14" x 7"	1521507-410	
	REAR	14" x 8"	1521508-410	

P 4301 BEADLOCK

	FRONT/REAR	WEIGHT: 7.3 KG	LOAD RATING: 729 KG	OFFSET: +38
ACCENT	FRONT/REAR	14" x 7"	1523284	
MATTE BLACK	FRONT/REAR	14" x 7"	1523283	

Q HD DUAL BEADLOCK

	FRONT/REAR	WEIGHT: 18.1 KG	LOAD RATING: 725.7 KG	OFFSET: +38
MATTE BLACK	FRONT/REAR	14" x 7"	1524022-458	

FORGED BEADLOCK RINGS

○ BEADLOCK REQUIRED

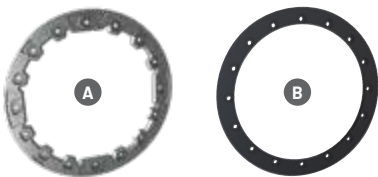

14" FORGED BEADLOCK RINGS

A MACHINED 1522244-266

ONLY USED ON 4203 BEADLOCK & HD DUAL BEADLOCK
SOLD INDIVIDUALLY

B MATTE BLACK 1523146-458

ONLY USED ON 4301 BEADLOCK & HD DUAL BEADLOCK
SOLD INDIVIDUALLY

15" FORGED BEADLOCK RINGS

A MACHINED 1522240-266

ONLY USED ON 5203 BEADLOCK
SOLD INDIVIDUALLY

B MATTE BLACK 1523147-458

ONLY USED ON 5301 BEADLOCK
SOLD INDIVIDUALLY

HD PARTS

P. 120

KNOW YOUR TERRAIN



- Tread patterns optimized for extreme traction
- Ideal for both hard pack and loose trail



- Flexible "grippy" tread
- Aggressive side bite



- Provides traction and durability
- Built to perform in hard sand, jagged rocks or any other extreme terrain

WHEEL & TYRE SETS

14" 40-SERIES	UTILITY			DESERT/ROCK	MUD/TRAIL		BACKCOUNTRY/TRAIL		
	HARVESTER		PRESERVE	CRAWLER XR	MUD XC		ATTACK	DUAL-THREAT	
	27"	28"	27"	28"	27"	29"	26"	26"	29"
4201 ○ ACCENT	2882388	2883225	2883208	2882394	2884272	2884265	2882390	2883138	2883146
4201 ○ MATTE BLACK	2882389	2883226	2883209	2882395	2884273	2884266	2882391	2883139	2883147
4202 ○ ACCENT	2882383	2883220	2883203	2881343	2884267	2884260	2881335	2883140	2883148
4202 ○ MATTE BLACK	2882384	2883221	2883204	2881344	2884268	2884261	2881336	2883141	2883149
4203 BEADLOCK MATTE BLACK BEADLOCKS SOLD SEPARATELY				2881386			2881381		
4204 ACCENT	2882385	2883222	2883205	2881355	2884270	2884263	2881347	2883142	2883150
4204 ○ MATTE BLACK	2882386	2883223		2881356	2884271	2884264	2881348	2883143	2883151
4205 ○ LUSTER				2881371			2881359		
4205 ○ MATTE BLACK	2882387	2883224	2883207	2881372	2884269	2884262	2881360	2883144	2883152
4301 BEADLOCK ○ ACCENT BEADLOCKS PRE-MOUNTED				2883213				2883217	2883219
4301 BEADLOCK ○ MATTE BLACK BEADLOCKS PRE-MOUNTED				2883212					

XD 1500 WHEEL & TYRE SETS

15" 50-SERIES	UTILITY		MUD/TRAIL	DESERT/ROCK		CRAWLER XG		CRAWLER XP		CRAWLER XR	
	HARVESTER	HARVESTER	MUD XC	CRAWLER AT	CRAWLER XG	CRAWLER XP	CRAWLER XP	CRAWLER XR	CRAWLER XR	CRAWLER XR	CRAWLER XR
	30"	32"	30"	30"	32"	30"	32"	30"	32"	30"	32"
5206 ○ MATTE BLACK	2889940	2889943	2890842	2889941		2889939	2890026	2889947	2889949	2890847	2885016
5302 BEADLOCK ○ MATTE BLACK	2889936	2889942	2890841	2889937		2889935	2890025	2889946	2889948	2890846	2885010
5304 ○ MATTE BLACK	2889996	2889945	2890674	2889999	2890000	2889995	2890027	2890672	2889997	2890673	2889998
5306 ○ MATTE BLACK	2890949	2890950	2890948	2890941	2890942	2890938	2890939	2890946	2890947	2890943	2890944
5307 ○ MATTE BLACK	2890968	2890969	2890967	2890960	2890961	2890957	2890958	2890965	2890966	2890962	2890963
5307 BEADLOCK ○ MATTE BLACK	2890987	2890988	2890986	2890979	2890980	2890976	2890977	2890984	2890985	2890981	2890982

2 WAYS TO PURCHASE
INDIVIDUAL WHEELS & TYRES
- OR - COMPLETE SETS AS LISTED

Exclusively at Polaris Authorized Dealers

COMMON ACCESSORIES

CONNECTED TECHNOLOGY

ELECTRICAL ACCESSORIES

TRACKS

COOLERS

HUNT

WINCHES

LIGHTING

WHEELS & TYRES



- Extra deep treads
- Self-cleaning lugs



- Triple-belted sidewalls to resist puncture
- Purpose-built, long lasting tread patterns



- Handles extreme cold
- Holds shape and provides traction

NEW
TREKKER**X TERRAIN**

27"		29"	
TREKKER		X TERRAIN	
27"	29"	27"	29"
		2889966	2889976
		2889967	2889977
2890907	2890906	2889968	2889978
2890905	2890904	2889969	2889979
		2889972	2889982
		2889973	2889983
		2889974	2889984
		2889975	2889985
		2889970	2889980
		2889971	2889981

**50-SERIES****TRAIL****DESERT/ROCK**

	ATTACK 2.0 28"	CRAWLER XG 28"
5201 ACCENT	2883160	2883188
5201 MATTE BLACK	2883159	2883187
5202 ACCENT	2883158	2883186
5202 MATTE BLACK	2883157	2883185
5203 BEADLOCK ACCENT BEADLOCKS SOLD SEPARATELY	2883154	2883182
5204 MATTE BLACK	2883155	2883183
5301 BEADLOCK ACCENT BEADLOCKS PRE-MOUNTED	2883162	2883190
5301 BEADLOCK MATTE BLACK BEADLOCKS PRE-MOUNTED	2883161	2883189

REPLACEMENT CAPS**POLARIS CAPS**

HD <small>HEAVY DUTY PARTS</small> MATTE BLACK	ALL WHEELS	5457498-458
--	------------	-------------

PRO ARMOR CAPS

LUSTER	ALL WHEELS EXCEPT 5204 & 5203 BEADLOCK	5453209-410
MATTE BLACK		5453209-458
MATTE BLACK	5204	1523063-458
LUSTER	5203 BEADLOCK	1523015-410
MATTE BLACK		1523015-458

LUG NUTS **LUG NUTS REQUIRED****12MM x 1.5 SPLINED LUG NUTS**

16 LUG NUTS WITH WRENCH	ALL POLARIS RANGER 3-SEAT & CREW MODELS	2879332
4 LUG NUTS WITHOUT WRENCH		2879331
SPLINED LUG WRENCH		2204966

3/8" - 24 HEX LUG NUTS

16 HEX LUG NUTS	ALL POLARIS RANGER 570 '20-21 MODELS	2877409
4 HEX LUG NUTS		2876754

BACKCOUNTRY/TRAIL

ATTACK 2.0		DUAL-THREAT	PRO RUNNER		TREKKER	
30"	32"	32"	30"	32"	30"	32"
2889938			2890845	2885017	2890920	2890925
2889934		2885009	2890844	2885011	2890921	2890926
2889994	2890675	2891026	2890843		2891006	2891007
2890932	2890933	2890934	2890935	2890936	2890917	2890922
2890951	2890952	2890953	2890954	2890955	2890918	2890923
2890970	2890971	2890972	2890973	2890974	2890919	2890924

**TYRE SEALANT**

P. 124

- » 946 ML • 2830484
- » 3.8 LITERS • 2830485
- » 19 LITERS • 2830486
- » 19 LITERS PUMP • 2830487

POLARIS **RANGER**



POLARIS

Think Outside

Polaris reserves the right to withdraw any product from sale or change specifications and pricing without notice. Confirm model specifications and availability with your Polaris Dealer prior to ordering. The Polaris range is not intended for and may not be registered for on-road use. All photography taken with professional riders and drivers. For your safety, always operate Polaris products as instructed in the product manual and on warning labels. Never carry passengers on any product not designed for such use. Preserve your future riding opportunities by showing respect for the environment, local laws and the rights of others. Avoid excessive speeds and be particularly careful on difficult terrain. Polaris Sales Australia Pty Ltd ABN 62 088 081 949.